



EVOLine[®] ePlace Design

Ladies and Gentlemen,

EVoline offers intelligent solutions for all your needs for the distribution of electricity and data – from a single plug to electrical installations of entire buildings. We focus on uncompromising quality in technology and design, on flexible modular systems and, last but not least, on products for a decentralised electrical distribution system realizing its full potential of economics, sustainability and safety.

You are our co-designer developing customised solutions – select EVoline products and modules from our catalogue to meet your bespoke requirements exactly.

The new EVoline Configurator supports you online, and should you prefer, please contact us directly to discuss your specific connectivity needs.

Sincerely



A handwritten signature in black ink, appearing to read 'Siegfried Schulte'.

Siegfried Schulte



A handwritten signature in black ink, appearing to read 'Steffen Waldminghaus'.

Steffen Waldminghaus

New Products



EVoline®
Square80
Innovative technology for
the smallest of spaces.

Page 6



EVoline®
Charger Qi
Pure minimalism.

Page 10



EVoline®
BackFlip
Enhanced protection for
the home.

Page 14



EVoline®
V-Port
Connectivity for corners
everywhere.

Page 18



EVoline®
Rail
Intelligent under desk
storage and cable
management.

Page 23



EVoline®
Quicklock
A quick & secure
concealed mounting
system.

Page 26



EVoline®
PlugFix
Fully assembled.

Page 31

Contents



**EVOLine®
Philosophy**
For all who like an
optimal ePlace.

Page 34



**EVOLine®
Configurator**
Be a Co-Designer

Page 38



**EVOLine®
Port**
The retractable
solution.

Page 41



**EVOLine®
FlipTop**
Flush fitting for
seamless integration.

Page 46



**EVOLine®
FrameDock**
A flexible modular
system for everywhere.

Page 52



**EVOLine®
Dock**
Above desk quality for
home, office, hotel.

Page 57



**EVOLine®
R-Dock**
Contemporary and
modern for all
worksurfaces.

Page 61



**EVOLine®
U-Dock**
Underdesk. Robust.
Save.

Page 65



**EVOLine®
V-Dock**
Convenient.

Page 69



**EVOLine®
T-Dock**
At home in the kitchen.

Page 72



**EVOLine®
Vertical
Stable.**
Spacesaving.

Page 77



**EVOLine®
Caddy**
Wheeled.
Custom-made.

Page 81

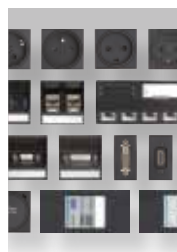

**EVOLine®
Modules**
Endless possibilities.

Page 84



**EVOLine®
Express**
Cascadable.
Extendable.
International.

Page 99



**EVOLine®
Plug**
Extremely thin.
Fits behind any cupboard
or cabinet.
Prevents tripping hazards.
Page 105



**EVOLine®
Cable Management**
From floor to table top.

Page 109



**EVOLine®
Fixings /
Accessories**
Custom-made.

Page 113

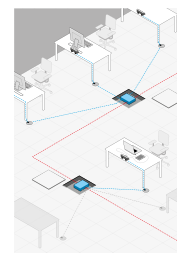

**EVOLine®
Decentralised
Electrical
Distribution**
Plan with EVOLine
Consolidation Points.
Page 116



**EVOLine®
References**
Decentralised electrical
distribution –
right from the start.

Page 122



**EVOLine®
Consolidation Point**
The modular hub.

Page 131



**Schulte
Elektrotechnik**
Who we are – where you
can find us.

Page 136



EV0line® Square80



EVoline® Square80

Many desks have pre-made openings for cables with a diameter of 80mm. EVoline Square80 fits into this standard opening combining a power socket, a USB charging socket, and a network connection.

In its Qi version EVoline Square80 offers an additional inductive charging surface integrated into the cover, for charging all Qi capable mobile phones per WPC Standard 1.1.

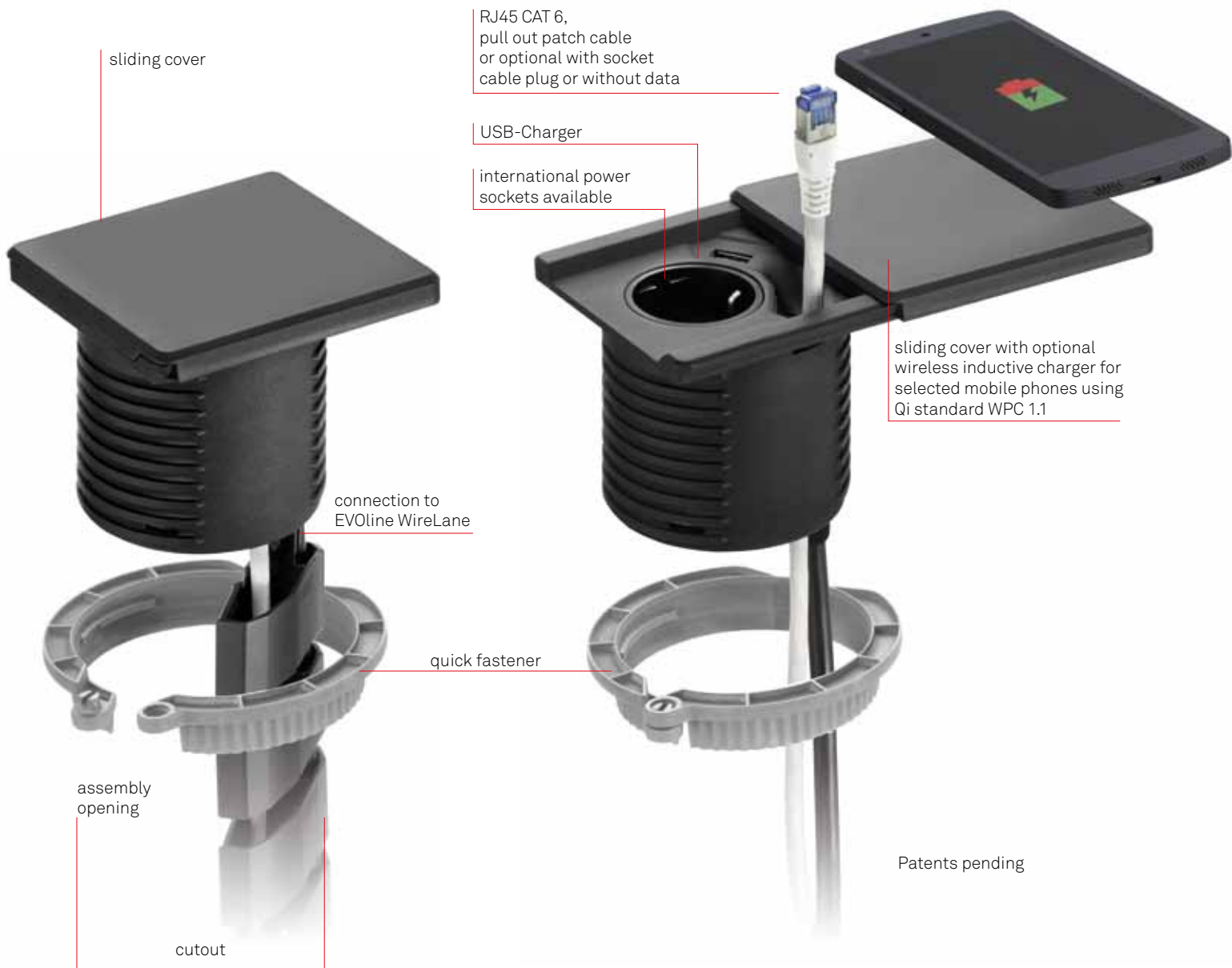

Patents pending

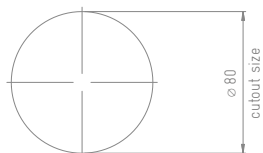
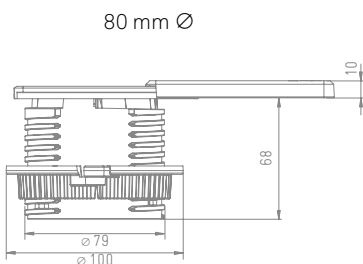

Dimensions in mm

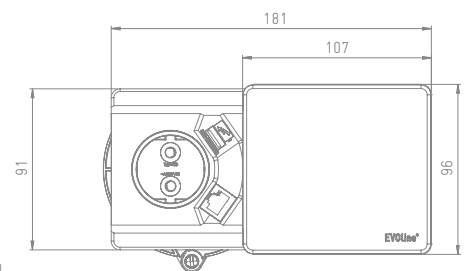

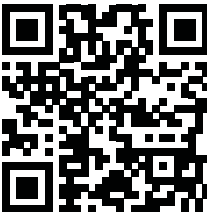
Description	Picture	Specification	Order number
<p>EVOLine Square80 Installation for surface thickness of up to 50 mm. Mounting hole ø 80 mm. Configuration: 1 power outlet, VDE-compliant, 16 A, contact-protected, 1 x USB Type A Charger, charging function only - ideal for charging of USB-chargeable devices, i.e. Apple iPhones, iPads, iPods**, Tablets, Smart phones, MP3 Players.</p> <p>Fixed supply cable 3.0 m with angled plug.</p> <p>For the complete cable management solution, we recommend EVOLine WireLane and EVOLine Bridge to cover exposed cables. Available to order separately.</p>		<p>Without Qi charging function Cover and housing black</p>	1592 7000 0100
<p>Fixed supply cable 3.0 m with angled plug.</p>		<p>With CAT 6 socket, 3,0 m cable and plug</p>	1592 7000 0200
<p>For the complete cable management solution, we recommend EVOLine WireLane and EVOLine Bridge to cover exposed cables. Available to order separately.</p>		<p>With CAT6 pull-out patch cable 3.0 m</p>	1592 7000 0300
<p>International versions available upon request.</p>		<p>Without data</p>	1592 7000 1900
<p>The USB charging function cannot be guaranteed due to the multitude of manufacturers and devices on the market.</p>		<p>Cover and housing white With CAT 6 socket, 3,0 m cable and plug</p>	1592 7000 2000
<p>* For all Qi-compliant mobile phones with WPC standard 1.1</p>		<p>With CAT6 pull-out patch cable 3.0 m</p>	1592 7000 2100
<p>** ™ Apple Computer Inc.</p>		<p>Without data</p>	1592 7000 3100
<p>Become a co-designer and select your country-specific EVOLine Square80.</p>		<p>Cover in stainless steel optics, housing in black With CAT 6 socket, 3,0 m cable and plug</p>	1592 7000 3200
<p>Directly to EVOLine Configurator.</p>		<p>With CAT6 pull-out patch cable 3.0 m</p>	1592 7000 3300
<p>www.evoline.com/konfigurator</p>		<p>Without data</p>	1592 7000 0400
	<p>Cover and housing black With CAT 6 socket, 3,0 m cable and plug</p>	1592 7000 0500	
	<p>With CAT6 pull-out patch cable 3.0 m</p>	1592 7000 0600	
	<p>Without data</p>	1592 7000 2200	
	<p>Cover and housing white With CAT 6 socket, 3,0 m cable and plug</p>	1592 7000 2300	
	<p>With CAT6 pull-out patch cable 3.0 m</p>	1592 7000 2400	
	<p>Without data</p>	1592 7000 3400	
	<p>Cover in stainless steel optics, housing in black With CAT 6 socket, 3,0 m cable and plug</p>	1592 7000 3500	
	<p>With CAT6 pull-out patch cable 3.0 m</p>	1592 7000 3600	
	<p>Without data</p>	1592 7000 3600	

Directly to EVOLine Configurator.
www.evoline.com/konfigurator

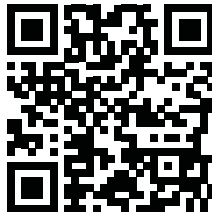



EV0line® Charger Qi

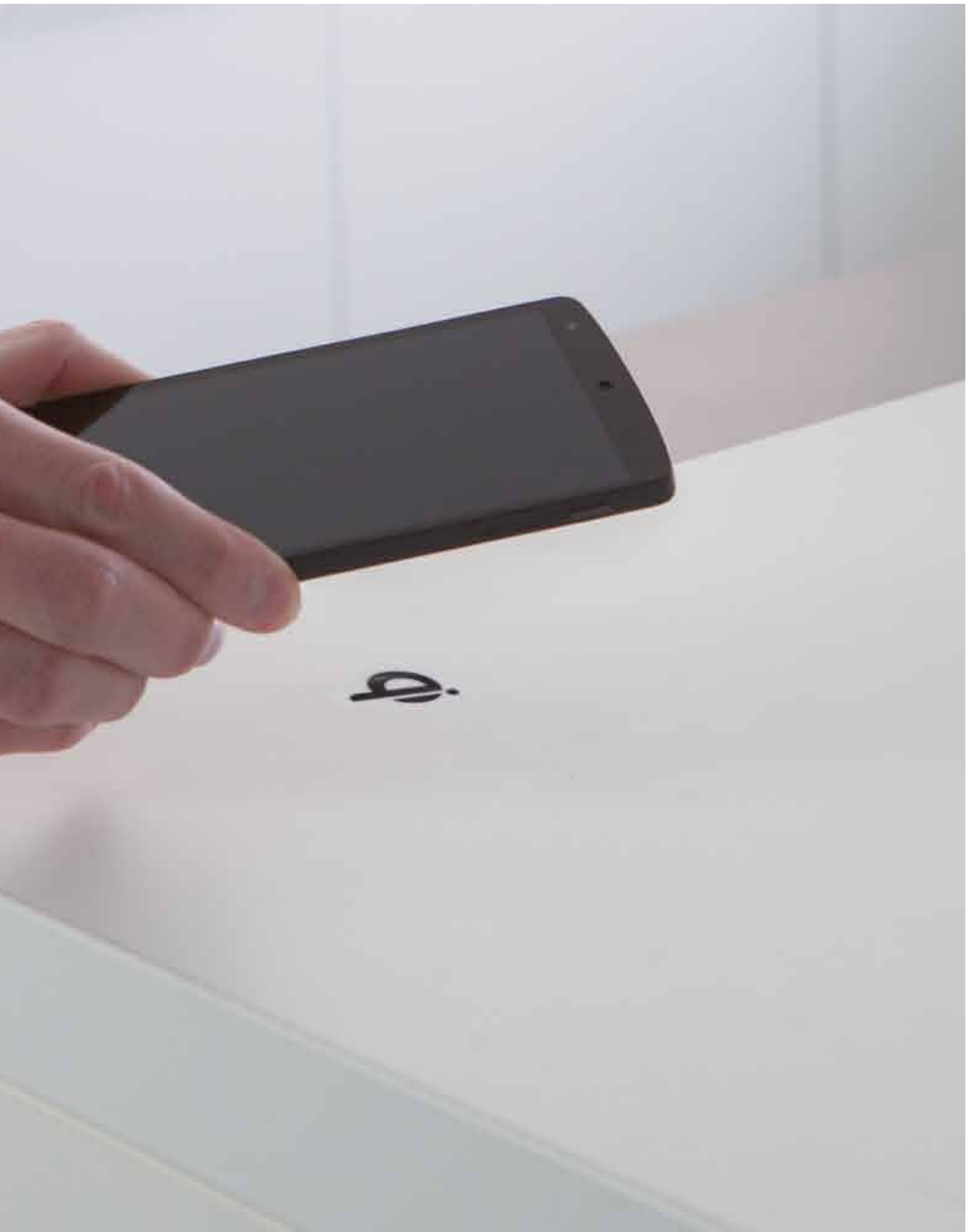

Pure minimalism.

EVOLine® Charger Qi

EVOLine Charger Qi enables charging of Qi-compatible devices without cables or any other accessories on a single charging station. Installed below the desk or work surface, the charger is completely invisible.

Simply place the device to be charged on the work surface above – pure minimalism.

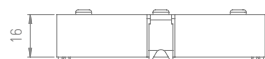
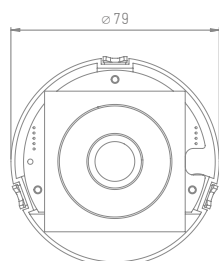

Dimensions in mm

Description

Picture

Specification

Order number

EVOLine Charger Qi

Charges Qi-compatible mobile devices according to WPC Standard Spec. 1.1
The charging coil is mounted below the work surface (desk, kitchen counter etc.) and allows wireless charging on the work surface.



EVOLine Charger Qi

Operating voltage: 19V;
external power supply unit
230 V with 1.5 m cable

1599 0910 0500



EVoline® BackFlip



EVoline® BackFlip

When closed, the BackFlip fits flush on the work surface, giving enhanced protection against liquid spillages. At a touch of a finger, it flips 180 degrees to reveal its function. Two power sockets and a USB charger are revealed. The raised position provides further protection against spillages. With a total installation height of just 53 mm, the BackFlip can be fitted above most drawers, including a fitted cutlery drawer.

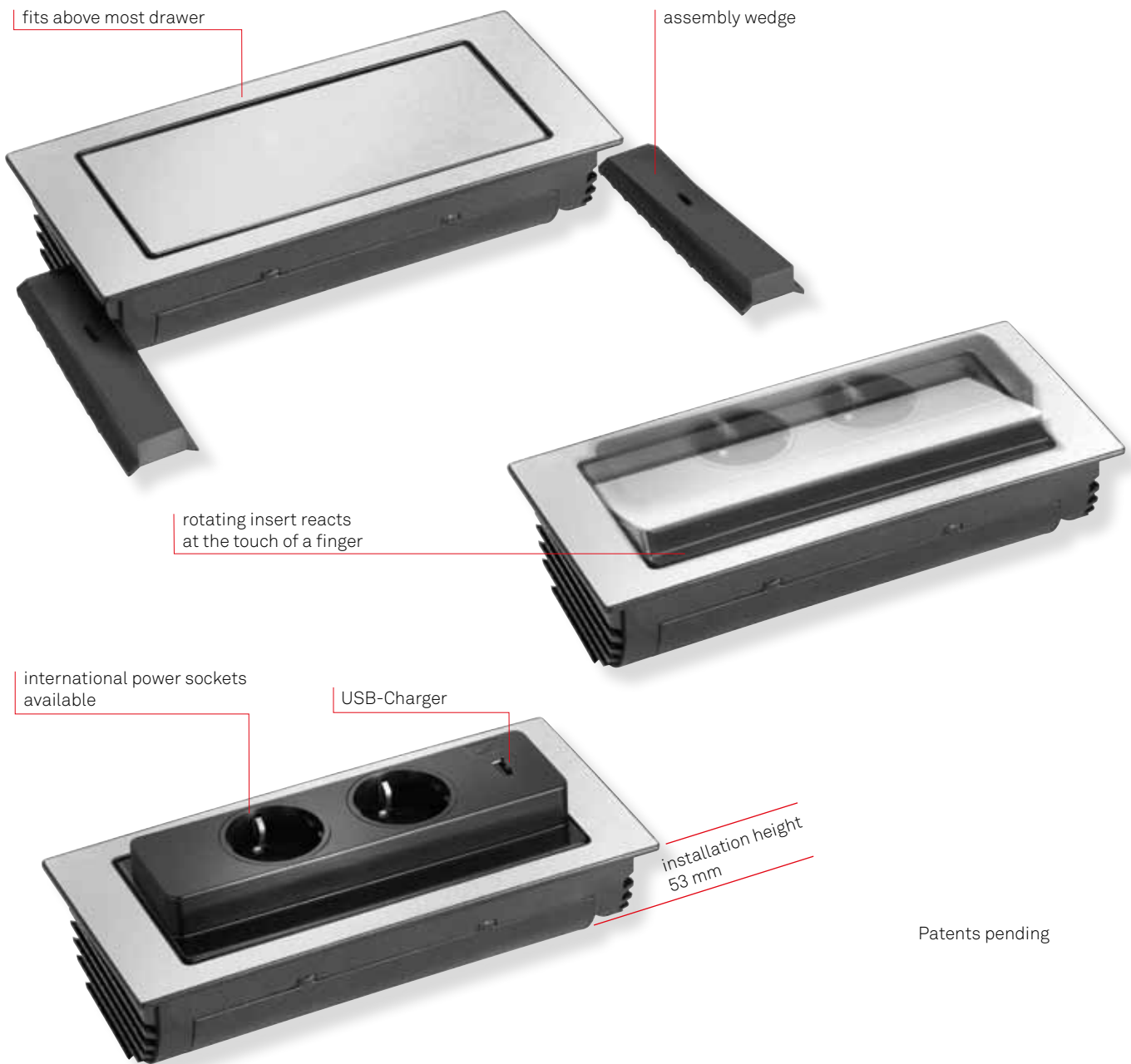

Patents pending

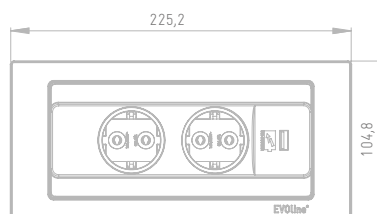
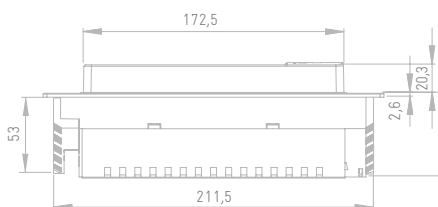

Dimensions in mm

Description	Picture	Specification	Order number
<p>EVoline BackFlip For work surfaces with thickness of up to 40 mm. Overall installation height: 53 mm</p> <p>Decor in brushed stainless steel, housing for electrical connections in black plastic.</p> <p>Configuration: Two sockets, VDE-compliant, 0°, 16 A, contact-protected 1x USB Type A Charger, charging function only - ideal for charging of USB-chargeable devices, i.e. Apple iPhones, iPads, iPods**, Tablets, Smart phones, MP3 Players.</p> <p>The USB charging function cannot be guaranteed due to the multitude of manufacturers and devices on the market.</p> <p>** TM Apple Computer Inc.</p>		<p>EVoline BackFlip Standard Fixed power supply cable 3.0 m with plug</p> <p>EVoline BackFlip Cuisine Fixed power supply cable 2.5 m with wire ferrules, plug supplied unattached</p> <p>EVoline BackFlip Plug Fixed power supply cable 3.0 m, with EVoline Plug</p>	<p>1592 7100 0200</p> <p>1592 7100 0100</p> <p>1592 7100 0900</p>

Become a co-designer and select your country-specific EVoline BackFlip.

Directly to EVoline Configurator.
www.evoline.com/konfigurator

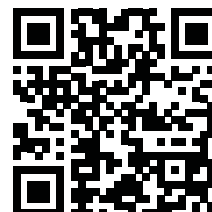



EV0line® V-Port



EVoline® V-Port

In kitchens, you often find unused space underneath a wall cabinet, especially in corners and next to tall cupboards. This is where the EVoline V-Port can be installed. In its closed position, the V-Port is concealed within a discreet and elegant housing lacquered in stainless steel effect. A gentle touch releases a multiple socket rail. As option with USB charger.

quick mounting,
easy connection
via special connector



EVoline VDE Plug
is standard



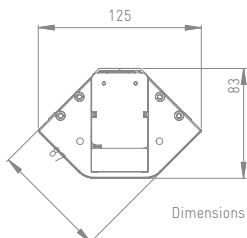
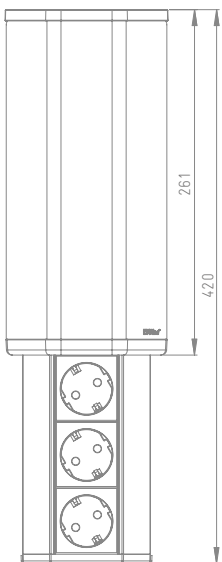

international
double or triple
power sockets
available

USB-Charger
optional



soft touch release



Description	Picture	Specification	Order number
<p>EVoline V-Port Aluminium housing, black anodised, for right-angle installation. VDE-compliant sockets, 60°, 16 A, contact-protected. Supply cable 2.5 m with plug-in connector. All configurations with VDE-compliant sockets with fixed EVoline Plug. Other versions with wire-end ferrules and country-specific plug, supplied unattached.</p>		<p>EVoline V-Port With two sockets</p>	1593 4500 0200
<p>EVoline V-Port with USB-Charger Aluminium housing, black anodised, for right-angle installation. VDE-compliant sockets, 60°, 16 A, contact-protected. Supply cable 2.5 m with plug-in connector. All configurations with VDE-compliant sockets with fixed EVoline Plug. Other versions with wire-end ferrules and country-specific plug, supplied unattached.</p> <p>1x USB Type A Charger, charging function only - ideal for charging of USB-chargeable devices, i.e. Apple iPhones, iPads, iPods**, Tablets, Smart phones, MP3 Players.</p>		<p>EVoline V-Port With two sockets and one USB Type A charger</p>	1593 4500 0300

International versions available upon request.

The USB charging function cannot be guaranteed due to the multitude of manufacturers and devices on the market.

** TM Apple Computer Inc.

Become a co-designer and select your country-specific EVoline V-Port.

Directly to
EVoline
Configurator.
[www.evoline.com/
konfigurator](http://www.evoline.com/konfigurator)

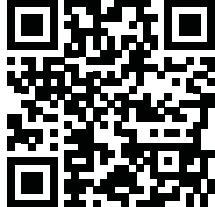

EV0line® Rail

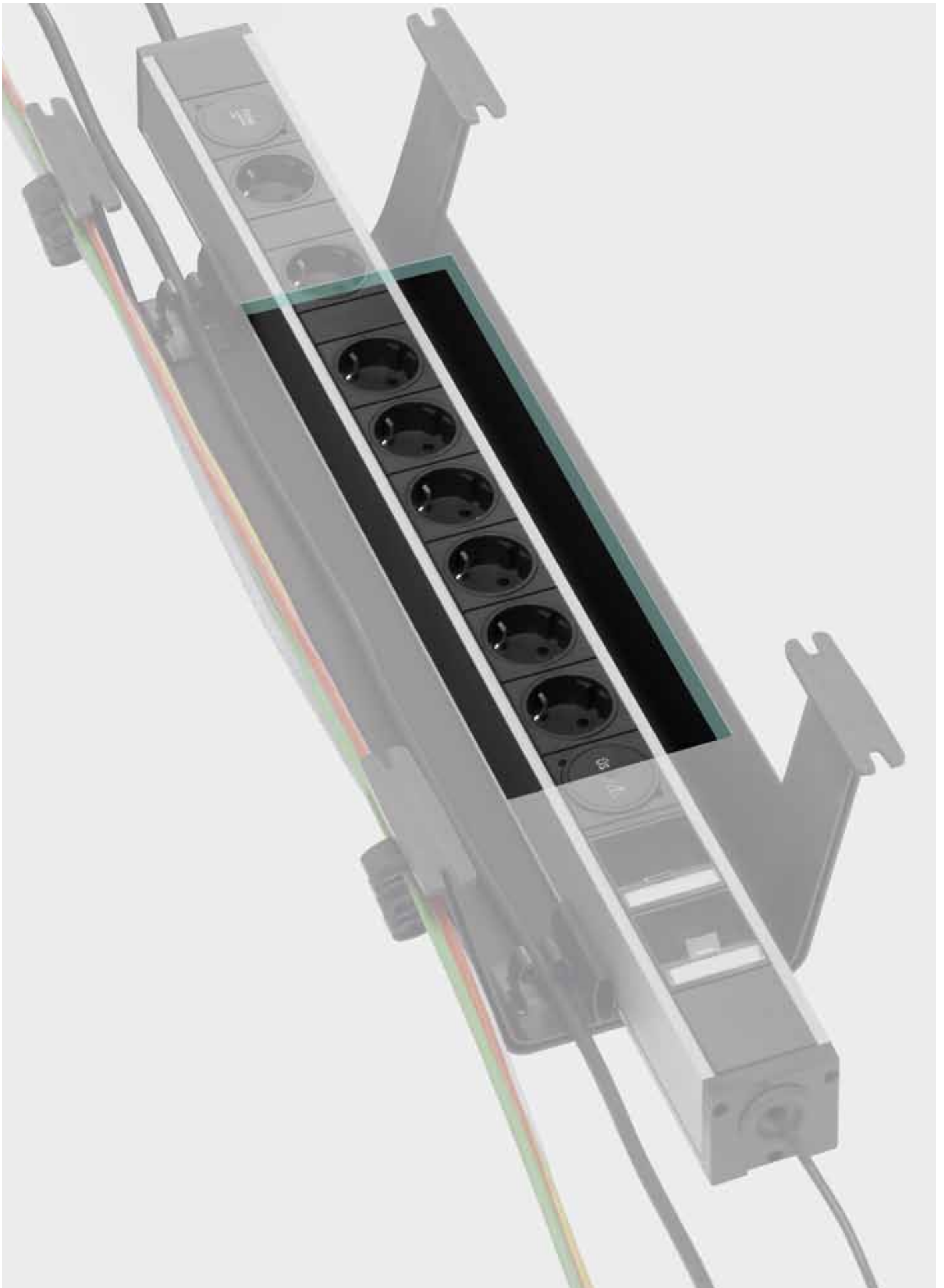

EVOLine® Rail

An intelligent under desk storage and cable management system which is easy to install in any location. Customisable to individual requirements and a variety of lengths, EVOLine Rail ensures power units and cables to be organized underneath workspaces. In addition, using the EVOLine WireLane connection, cables can be consolidated and concealed down to the floor.



EVOLine Rail can be relocated with minimum impact to desk and work surfaces.

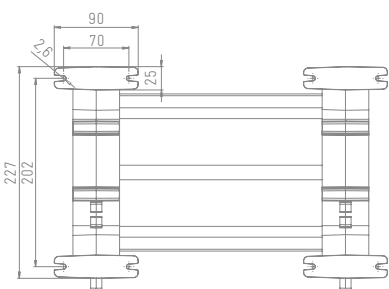

Dimensions in mm

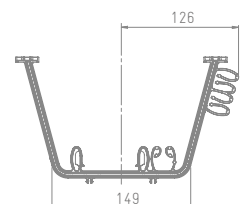
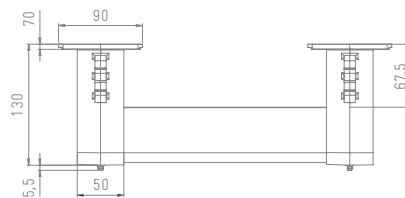

Description	Picture	Specification	Order number
-------------	---------	---------------	--------------

EVoline Rail
 For under desk installation, the EVoline Rail is available for the EVoline U-Dock and EVoline Express range.

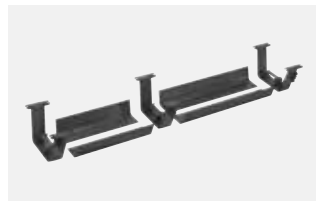

EVoline Rail
 For EVoline U-Dock
 Consisting of
 2 black plastic brackets
 and
 2 black aluminum profiles
 Profile length 150 mm 1593 5400 0700
 Profile length 300 mm 1593 5400 0100
 Profile length 500 mm 1593 5400 0200

Consisting of
 3 black plastic brackets
 and
 4 black aluminum profiles
 Profile length 2 x 300 mm 1593 5400 0500
 Profile length 2 x 400 mm 1593 5400 0600

EVoline Rail
 For EVoline Express
 Consisting of
 2 black plastic brackets
 and
 2 black aluminum profiles

 For Express type 910 with 3 sockets 1593 5400 0300
 For Express type 910 with 4 sockets 1593 5400 0400

Bespoke profile lengths available upon request.

Become a co-designer and configure your very own EVoline Product. Select from a variety of modules.

Directly to EVoline Configurator.
www.evoline.com/konfigurator

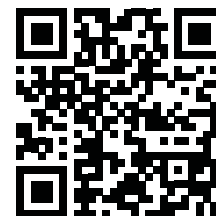

Rail for U-Dock fixings provide slideability.



Rail for fixed EVoline Express.



EV0line® Quicklock



A quick, secure & concealed mounting system.

EVoline® Quicklock

EVoline Quicklock provides a quick and secure fixing solution for the EVoline Dock and EVoline R-Dock range.

It easily mounts to the desk surface, requires no tools, is slip-free, and is also variable in length to fit all EVoline Dock profiles.

The power and data cables are hidden behind a cover plate, and extra space is available for surplus cables below the EVoline Docks.

With the optional EVoline WireLane connection, cables can be consolidated and concealed down to the floor.

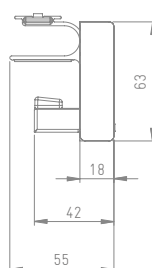
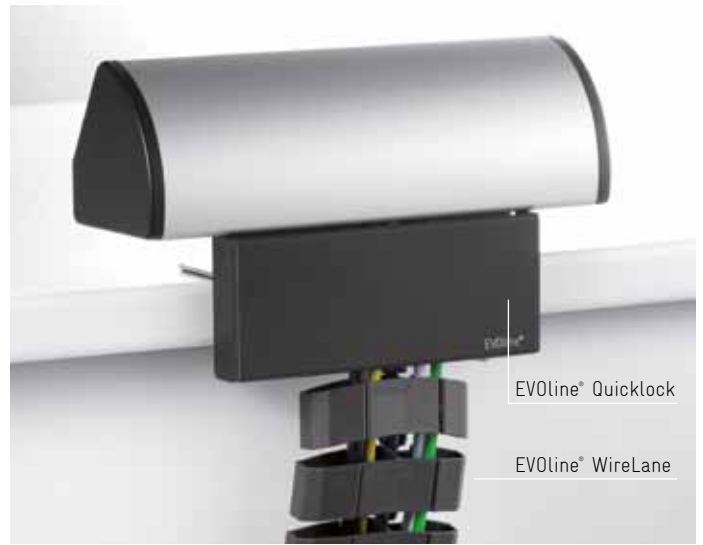

Dimensions in mm

Description	Picture	Specification	Order number
<p>EVoline Quicklock A fixing system with a concealed cable channel and 2 fasteners. For surface thickness of 18 to 32 mm.</p>		<p>EVoline Quicklock Length: 100 mm</p>	1599 0909 9200
<p>Installation without tools Fasteners with protective underlay.</p>		<p>Length: 150 mm includes brackets for EVoline WireLane connection</p>	1599 0909 9000
<p>Fits all EVoline Dock and EVoline R-Dock profiles.</p>		<p>Length: 200 mm includes brackets for EVoline WireLane connection</p>	1599 0909 9100
<p>For complete cable management solution, we recommend EVoline WireLane to cover exposed cables. Available to order separately.</p>		<p>Bespoke profile lengths available upon request.</p>	

Become a co-designer and
configure your very own
EVoline Product. Select from
a variety of modules.

Directly to
EVoline
Configurator.
[www.evoline.com/
konfigurator](http://www.evoline.com/konfigurator)

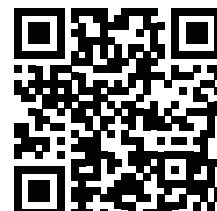

EV0line® PlugFix



Completely assembled.

EVoline® PlugFix

Fits behind every piece of furniture.
Easy to use.
Prevents tripping hazards.

Numerous awards for
function and design.

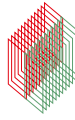

11. Designpreis des Landes
Nordrhein-Westfalen 2009
Universal Home:
Product Design
Ausgezeichnet
mit dem 1. Preis



reddot design award
winner 2011



Designpreis
Deutschland
2011
NOMINIERT



Winner



universal
design
consumer
award 2010



Ausgezeichnet mit der
IENA Goldmedaille



2012



Only with EVoline Plug:
Movable plug face for
ease of use and to prevent
tripping hazards



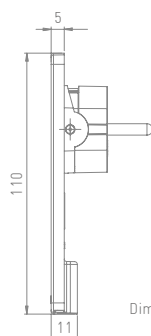
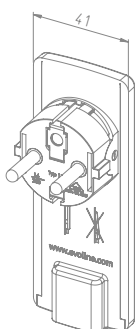

NEW!
With fixed cable
for volume orders
of OEM's.

Only 5 mm
housing thickness

International
Patents



Dimensions in mm

Description	Picture	Specification	Order number
<p>EVoline Plug Fix With fixed cable 3 x 1,5 mm², length 1,5 m, with wire-end ferrules. 250 V / 16 A.</p>		<p>EVoline Plug Fix black with black cable</p>	<p>1510 0015 1100</p> 
		<p>EVoline Plug Fix white with white cable</p>	<p>1510 0015 1300</p> 

More power supply modules
 available via our
 EVoline Configurator.

Directly to
 EVoline
 Configurator.
[www.evoline.com/
 konfigurator](http://www.evoline.com/konfigurator)

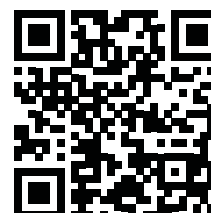



The EV0line® Philosophy

Different challenges require different solutions.

With a wide range of products EV0line covers most challenges regarding electrification, data transport, multimedia connection, and security of your ePlace.

Furthermore, the entire EV0line modular system enables completely individual solutions for each user. From a simple plug to the decentralized electrical installation of entire buildings, EV0line offers custom-made intelligent solutions.

Configure your own ePlace and become a co-designer – even in low-volume orders.

We are happy to assist you.



Dock Standard



Example of an individually configured R-Dock.

Maximum Individuality: the EV0line® Modular System

The modular approach of EV0line products opens nearly endless possibilities of bespoke configuration and connectivity solutions.

Be it for the electrification of work places in an open-plan office or in the kitchen at home: EV0line offers a perfect solution for every challenge.



EV0line Port



EV0line V-Port



EV0line Dock



EV0line Flip Top



EV0line V-Dock



EV0line U-Dock



EV0line R-Dock



EV0line Frame Dock



EV0line T-Dock

EVoline products can be equipped with a wide range of switches, sockets, and modules for data, multimedia and safety.

A wide range of modules is available on our website:
www.evoline.com

Directly to
EVoline
Configurator.
[www.evoline.com/
konfigurator](http://www.evoline.com/konfigurator)

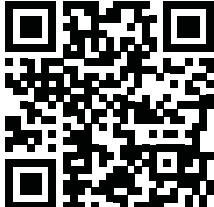

Become a Co-Designer: With EVOLine® Configurator

With just a few clicks design the product you want: It's no problem with the new EVOLine Configurator.

Standard or custom-made product: The new EVOLine configurator offers more than 22000 possibilities – and all the information about the product you want.

Select country where the product will be used:

Country selection	<input checked="" type="checkbox"/> Germany	<input type="checkbox"/> Austria	<input type="checkbox"/> Netherlands	<input type="checkbox"/> Italy	<input type="checkbox"/> Portugal
	<input type="checkbox"/> Spain	<input type="checkbox"/> Sweden	<input type="checkbox"/> Norway	<input type="checkbox"/> Finland	<input type="checkbox"/> Slovenia
	<input type="checkbox"/> France	<input type="checkbox"/> Belgium	<input type="checkbox"/> Poland	<input type="checkbox"/> Slovakia	<input type="checkbox"/> Czech Rep.
	<input type="checkbox"/> Great Britain	<input type="checkbox"/> North. Ireland	<input type="checkbox"/> Ireland	<input type="checkbox"/> Singapore	<input type="checkbox"/> Malaysia
	<input type="checkbox"/> Switzerland	<input type="checkbox"/> Liechtenstein	<input type="checkbox"/> Denmark	<input type="checkbox"/> Australia	<input type="checkbox"/> New Zealand
	<input type="checkbox"/> USA	<input type="checkbox"/> Canada	<input type="checkbox"/> Mexico	<input type="checkbox"/> Argentina	<input type="checkbox"/> Jamaica

Select your product:



EVOLine product selection

Individuality – no problem.
Endless possibilities.
All components are approved internationally.
We are continuously extending our range of modules.

Directly to
EVoline
Configurator
[www.evoline.com/
konfigurator](http://www.evoline.com/konfigurator)

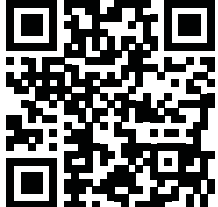

Select your modules:

Socket modules	
Data modules	
Multimedia modules	
Special modules	
Safety modules	
Switch modules	
Electrical supply modules	

Your configuration:



EV0line® Port



The retractable solution.

EVoline® Port



reddot
design award

With EVoline Port sockets and cables simply disappear. Typically just the collar and cover of the Port are visible on the work surface – with optional illumination by energy saving LEDs in blue, red, green, or white. A light pull-up motion lets the high-quality aluminum body appear from below and subsequently a push-down motion lets it disappear below the surface together even with attached plugs. The movable cover creates enough space for the cables.

EVoline Port was awarded the „red dot design award“.

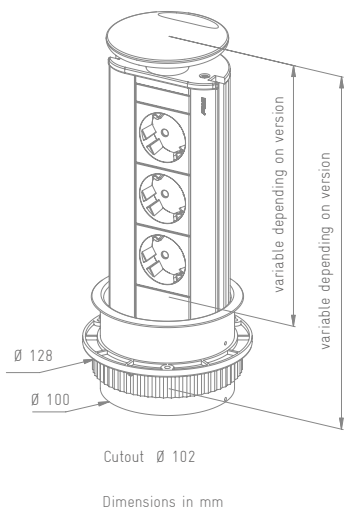

Description	Picture	Specification	Order number
<p>EVoline Port Aluminium housing, silver anodised. For work surface with thickness up to 50 mm. Mounting hole \varnothing 102 mm. Two sockets, VDE-compliant, 60°, 16 A, contact-protected. Fixed supply cable 3.0 m with angled plug.</p>		rocking cover and collar made of silver lacquered plastic	1593 1000 3300
rocking cover and collar made of black lacquered plastic		1593 1000 5200	
rocking cover made of solid stainless steel in CD design, collar made of plastic, lacquered in stainless steel optics		1593 1003 1100	
rocking cover made of solid stainless steel in CD design. Collar made of plastic, lacquered in stainless steel optics. NIGHTLIGHT effect by blue LEDs under rocking cover with illuminated ON/OFF switch		1593 1003 1200	
<p>EVoline Port Aluminium housing, silver anodised. For work surface with thickness up to 50 mm. Mounting hole \varnothing 102 mm. Three sockets, VDE-compliant, 60°, 16 A, contact-protected. Fixed supply cable 3.0 m with angled plug.</p>		rocking cover and collar made of silver lacquered plastic	1593 1000 0100
rocking cover and collar made of black lacquered plastic		1593 1000 5000	
rocking cover made of solid stainless steel in CD design, collar made of plastic, lacquered in stainless steel optics		1593 1002 1600	
rocking cover made of solid stainless steel in CD design. Collar made of plastic, lacquered in stainless steel optics. NIGHTLIGHT effect by blue LEDs under rocking cover with illuminated ON/OFF switch		1593 1003 1300	
<p>EVoline Port CUISINE Aluminium housing, silver anodised. For work surface with thickness up to 50 mm. Mounting hole \varnothing 102 mm. Three sockets, VDE-compliant, 60°, 16 A, contact-protected. Fixed supply cable 2.5 m with wire end ferrules, plug supplied unattached.</p>		rocking cover made of silver lacquered plastic, collar made of grey plastic	1593 1000 0600

EVOLine® Port

Description	Picture	Specification	Order number
<p>EVOLine Port DATA Aluminium housing, silver anodised. For work surface with thickness up to 50 mm. Mounting hole ø 102 mm. Two sockets, VDE-compliant, 60°, 16 A, contact-protected. Fixed supply cable 3.0 m with angled plug. Two modular couplings RJ45 to RJ45 CAT 6 shielded, 1:1 interconnected.</p>		<p>rocking cover and collar made of silver lacquered plastic</p> <p>rocking cover and collar made of black lacquered plastic</p> <p>rocking cover made of solid stainless steel in CD design, collar made of plastic, lacquered in stainless steel optics</p> <p>rocking cover made of solid stainless steel in CD design. Collar made of plastic, lacquered in stainless steel optics. NIGHTLIGHT effect by blue LEDs under rocking cover with illuminated ON/OFF switch</p>	<p>1593 1003 1400</p> <p>1593 1003 1500</p> <p>1593 1003 1600</p> <p>1593 1003 1700</p>
<p>EVOLine Port DATA Aluminium housing, silver anodised. For work surface with thickness up to 50 mm. Mounting hole ø 102 mm. Three sockets, VDE-compliant, 60°, 16 A, contact-protected. Fixed supply cable 3.0 m with angled plug. Two modular couplings RJ45 to RJ45 CAT 6 shielded, 1:1 interconnected.</p>		<p>rocking cover and collar made of silver lacquered plastic</p> <p>rocking cover and collar made of black lacquered plastic</p> <p>rocking cover made of solid stainless steel in CD design, collar made of plastic, lacquered in stainless steel optics</p> <p>rocking cover made of solid stainless steel in CD design. Collar made of plastic, lacquered in stainless steel optics. NIGHTLIGHT effect by blue LEDs under rocking cover with illuminated ON/OFF switch</p>	<p>1593 1003 1800</p> <p>1593 1003 1900</p> <p>1593 1003 2000</p> <p>1593 1003 2100</p>

Description	Picture	Specification	Order number
-------------	---------	---------------	--------------

EVoline Port USB CHARGER*

Aluminium housing, silver anodised. For work surface with thickness up to 50 mm.

Mounting hole ø 102 mm.

Two sockets, VDE-compliant,

60°, 16 A, contact-protected.

Fixed supply cable 3.0 m with angled plug.

1x USB Type A Charger, charging function only - ideal for charging of USB-chargeable devices i.e.

Apple (iPhones, iPads, iPods,) **

Tablets, Smart phones,

MP3 Players.



rocking cover and collar made of silver lacquered plastic

1593 1040 0200

rocking cover and collar made of black lacquered plastic

1593 1040 0300

rocking cover made of solid stainless steel in CD design, collar made of plastic, lacquered in stainless steel optics

1593 1040 0400

EVoline Port USB CHARGER*

Aluminium housing, silver anodised. For work surface with thickness up to 50 mm.

Mounting hole ø 102 mm.

Three sockets, VDE-compliant,

60°, 16 A, contact-protected.

Fixed supply cable 3.0 m with angled plug.

2x USB Type A Charger, charging function only - ideal for charging of USB-chargeable devices i.e.

Apple (iPhones, iPads, iPods,) **

Tablets, Smart phones,

MP3 Players.



rocking cover and collar made of silver lacquered plastic

1593 1038 4100

rocking cover and collar made of black lacquered plastic

1593 1038 7100

rocking cover made of solid stainless steel in CD design, collar made of plastic, lacquered in stainless steel optics

1593 1038 7200

The USB charging function cannot be guaranteed due to the multitude of manufacturers and devices on the market.

** ™ Apple Computer Inc.

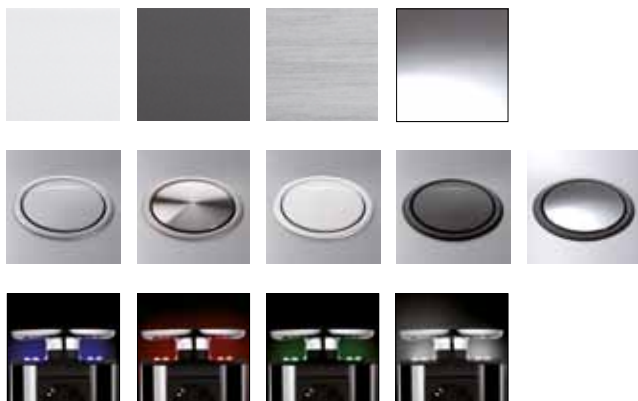

Become a co-designer and configure your very own EVoline Port. Select from various finishes, illuminations and modules for power, data, multimedia and safety.

Directly to
EVoline
Configurator.
[www.evoline.com/
konfigurator](http://www.evoline.com/konfigurator)

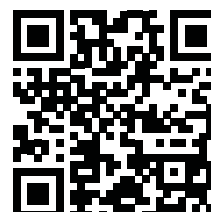



EVOLine® FlipTop



Flush fitting for seamless integration.

EVOLine® FlipTop

The EVOLine FlipTop is a smart discreet solution which provides connectivity for an unobstructed workspace.



Made from high quality stainless steel, the FlipTop is installed flush on the work surface and is an ideal solution for conference and meeting rooms. The FlipTop can be opened and offers easy access to power and data connectors. The opening and closing mechanism can be fixed at various angles preventing 'kinking' of cables, ensuring long term quality and performance. Cable outlet available with brush or rubber lip.

Cover movement:

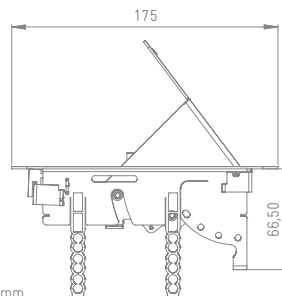
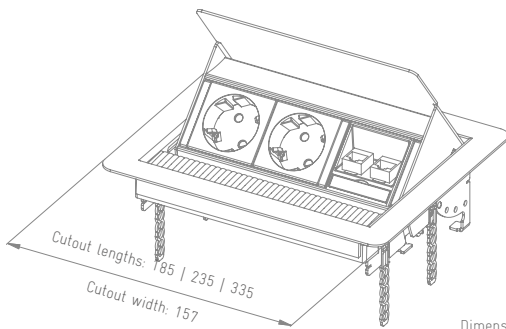

Closing resistance of the cover can be adjusted.



Dimensions in mm

Description	Picture	Specification	Order number
<p>EVOLine FlipTop SMALL For installation in work surfaces with thickness of 19 to 35 mm. Three sockets, VDE-compliant, 60°, 16 A, contact-protected. Fixed supply cable 3.0 m with plug. Fold out cover with click stops and end stop. Cable outlet with black brush strip. Installation dimensions: 185 x 157 mm</p>		<p>housing and cover made of brushed stainless steel</p>	<p>1593 4202 4900</p>
<p>EVOLine FlipTop CUISINE SMALL Fixed supply cable 2.5 m with wire end ferrules, plug supplied unattached. Fold out cover with click stops and end stop. Cable outlet with black rubber lip. Installation dimensions: 185 x 157 mm.</p>		<p>housing and cover made of brushed stainless steel</p>	<p>1593 4202 0700</p>
<p>EVOLine FlipTop DATA SMALL For installation in work surfaces with thickness of 19 to 35 mm. Two sockets VDE-compliant, 60°, 16 A, contact-protected. Fixed supply cable 3.0 m with plug. Two modular couplings RJ45 to RJ45 CAT6 shielded, 1:1 interconnected. Fold out cover with click stops and end stop. Cable outlet with black brush strip. Installation dimensions: 185 x 157 mm.</p>		<p>housing and cover made of brushed stainless steel</p>	<p>1593 4202 8100</p>

EVOLine® FlipTop

Description	Picture	Specification	Order number
<p>EVOLine FlipTop MEDIUM For installation in work surfaces with thickness of 19 to 50 mm, four sockets VDE-compliant, 60°, 16 A, contact-protected. Fixed supply cable 3.0 m with plug. Fold out cover with click stops and end stop. Cable outlet with black brush strip.</p> <p>Installation dimensions: 235 x 157 mm.</p>	 A rectangular stainless steel outlet plate with four circular sockets and a fixed cable on the right side.	housing and cover made of brushed stainless steel	1593 4200 2700
<p>EVOLine FlipTop CUISINE MEDIUM Fixed supply cable 2.5 m with wire end ferrules, plug supplied unattached. Fold out cover with click stops and end stop. Cable outlet with black rubber lip.</p> <p>Installation dimensions: 235 x 157 mm.</p>		housing and cover made of brushed stainless steel	1593 4200 0100
<p>EVOLine FlipTop DATA MEDIUM For installation in work surfaces with thickness of 19 to 50 mm, three sockets VDE-compliant, 60°, 16 A, contact-protected. Fixed supply cable 3.0 m with plug. Two modular couplings RJ45 to RJ45 CAT6 shielded, 1:1 interconnected. Fold out cover with click stops and end stop. Cable outlet with black brush strip.</p> <p>Installation dimensions: 235 x 157 mm.</p>	 A rectangular stainless steel outlet plate with three circular sockets and two RJ45 ports on the right side.	housing and cover made of brushed stainless steel	1593 4200 0200

NEW in Spring 2015

The new EVOLine FlipTop offers even more comfort, reacts on the touch of a finger and is easy to install.





Become a co-designer and configure your very own EVoline FlipTop. Select from various finishes and connection modules.

Directly to
EVoline
Configurator.

[www.evoline.com/
konfigurator](http://www.evoline.com/konfigurator)

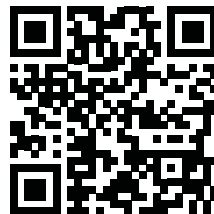



EV0line® FrameDock



A flexible modular system for everywhere.

EV0line® FrameDock

EV0line FrameDock is a flush fitting system which can be installed horizontally or vertically - be it on a desk surface, a kitchen worktop, a wall, or a side of a piece of furniture.

It can be mounted almost everywhere due to its low mounting depth of 51 mm and offers installation from the top - high quality design, customisable components and yet discreet.

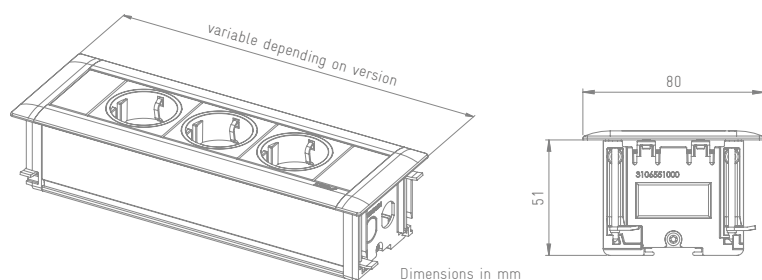

Description	Picture	Specification	Order number
-------------	---------	---------------	--------------

EVoline FrameDock SMALL
 Aluminium housing, silver anodised, for surface thickness of up to 38 mm. Three sockets, VDE-compliant, 0°, 16 A, contact-protected. Fixed supply cable 3.0 m with plug. Power entry in the underside of the profile.



With black screw covers 1596 1000 0900

EVoline FrameDock DATA SMALL
 Aluminium housing, silver anodised, for surface thickness of up to 38 mm. Three sockets, VDE-compliant, 0°, 16 A, contact-protected. Fixed supply cable 3.0 m with plug. Two modular couplings RJ45 to RJ45 CAT6 shielded, 1:1 interconnected. Power and data input through the underside of the profile.



With black screw covers 1596 1000 1000

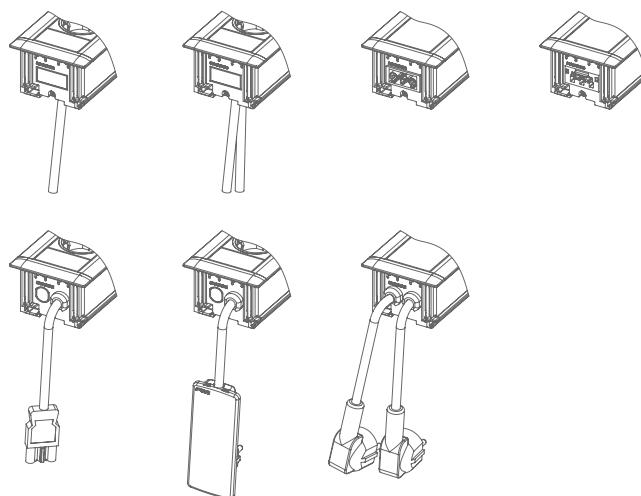

Become a co-designer and configure your very own EVoline FrameDock. Select from various electrical supply options and modules.

Directly to
 EVoline
 Configurator.
[www.evoline.com/
 konfigurator](http://www.evoline.com/konfigurator)

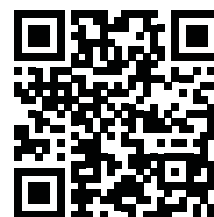

EVoline® Dock



Above desk quality for home, office, hotel.

EVoline® Dock

EVoline Dock sits above desk surface allowing maximum workspace. It's supported either by patented raising plastic mounting clamps or fixed in position by stainless steel clamps. The configurable charging and data station extends your work, private or social zone, including hotel rooms, equipped with international electrical sockets, and various multimedia, data and safety modules and switches.

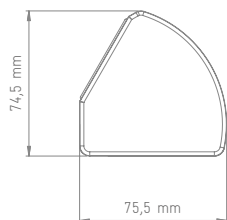
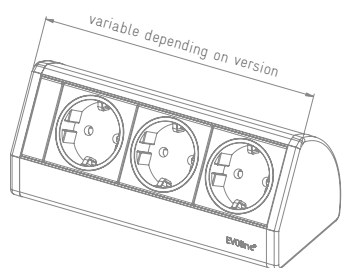

Dimensions in mm

Description	Picture	Specification	Order number	
<p>EVOLine Dock DESK Aluminium housing, free positioning with provided slide stops. Three sockets, VDE compliant, 0°, 16 A, contact-protected. Fixed supply cable 3.0 m with plug. Power supply cable entry in the left end cap.</p>		silver anodised	1593 0004 0300	
		black anodised	1593 0004 0100	
<p>EVOLine Dock DESK DATA Aluminium housing, free positioning with provided slide stops. Three sockets, VDE-compliant, 0°, 16 A, contact-protected. Fixed supply cable 3.0 m with plug. Two modular couplings RJ45 to RJ45 CAT6 shielded, 1:1 interconnected. Power supply cable entry in the left end cap.</p>		silver anodised	1593 0047 8300	
		black anodised	1593 0047 8100	
<p>EVOLine Dock SMALL Aluminium housing. Three sockets, VDE compliant, 0°, 16 A, contact-protected. Fixed supply cable 3.0 m. Power supply cable entry left side in the bottom of the profile.</p>		Incl. one mounting clamp for table tops with 8 - 40 mm thickness	silver anodised	1593 0066 6300
			black anodised	1593 0066 6100
		white powder-coated (RAL 9010)	1593 0066 6700	
		Without mounting clamp	silver anodised	1593 0003 9300
			black anodised	1593 0003 9100
			white powder-coated (RAL9010)	1593 0003 9700
<p>EVOLine Dock DATA SMALL Aluminium housing, three sockets, VDE-compliant, 0°, 16 A, contact-protected. Fixed supply cable 3.0 m with plug. Two modular couplings RJ45 to RJ45 CAT6 shielded, 1:1 interconnected. Power supply cable entry on the left side in the bottom of the profile.</p>		Incl. two mounting clamps for table tops with 8 - 40 mm thickness	silver anodised	1593 0066 2300
			black anodised	1593 0066 2100
		white powder-coated (RAL 9010)	1593 0066 2700	
		Without mounting clamp	silver anodised	1593 0047 7300
			black anodised	1593 0047 7100
			white powder-coated (RAL9010)	1593 0047 7700

EVoline® Dock

Description	Picture	Specification	Order number
<p>EVoline Dock DATA SMALL Aluminium housing, three sockets, VDE-compliant, 0°, 16 A, contact-protected. Fixed supply cable 3.0 m with plug. Two modular couplings RJ45 to RJ45 CAT6 shielded, 1:1 interconnected. Power supply cable entry on the left side in the bottom of the profile.</p>		<p>Fixing system: EVoline Quick-lock 150 mm + bracket for EVoline WireLane connection. For table tops with a thickness of 18 - 32 mm.</p> <p>silver anodised</p> <p>black anodised</p>	<p>1593 0389 7300</p> <p>1593 0389 7100</p>

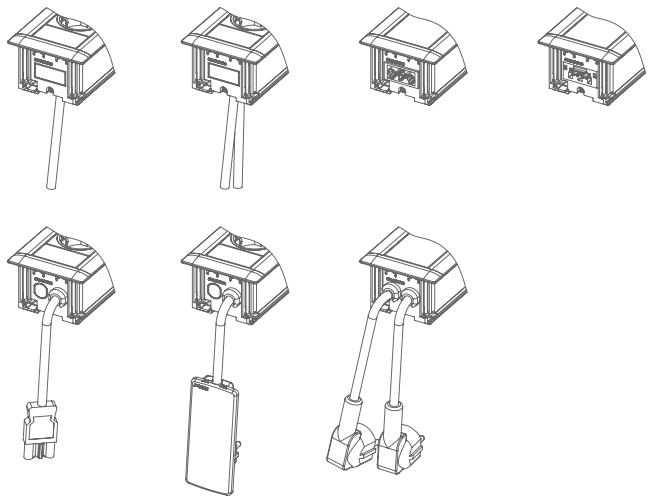

Become a co-designer and configure your very own EVoline Dock. Select from various finishes and modules for power, data, multimedia and safety as well as fixings.

Directly to
 EVoline
 Configurator.
[www.evoline.com/
 konfigurator](http://www.evoline.com/konfigurator)

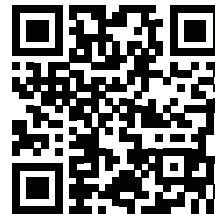

EVoline® R-Dock





Contemporary and modern for all workspaces.

EVOLine® R-Dock

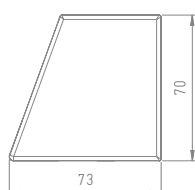
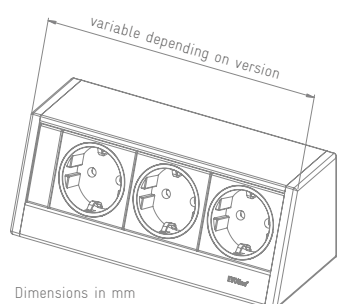
EVOLine R-Dock can be installed into any right angle corner. With its flat back and angled front fascia, it is comfortable to use. Install back to back on a flat surface for a double unit – obviously freely configurable.



Description	Picture	Specification	Order number
<p>EVoline R-Dock SMALL Aluminium housing, three sockets, VDE-compliant, 0°, 16 A, contact-protected. Fixed supply cable 3.0 m with plug. Power supply cable entry left side of the bottom of the profile.</p>		<p>silver anodised white powder-coated (RAL 9010) Fixing solutions to be ordered separately.</p>	<p>1598 0000 1700 1598 0000 8600</p>
<p>EVoline R-Dock DATA SMALL Aluminium housing, three sockets, VDE-compliant, 0°, 16 A, contact-protected. Fixed supply cable 3.0 m with plug. Two modular couplings RJ45 to RJ45 CAT6 shielded, 1:1 interconnected. Power supply cable entry left side of the bottom of the profile.</p>		<p>silver anodised white powder-coated (RAL 9010) Fixing solutions to be ordered separately.</p>	<p>1598 0000 1800 1598 0000 8700</p>

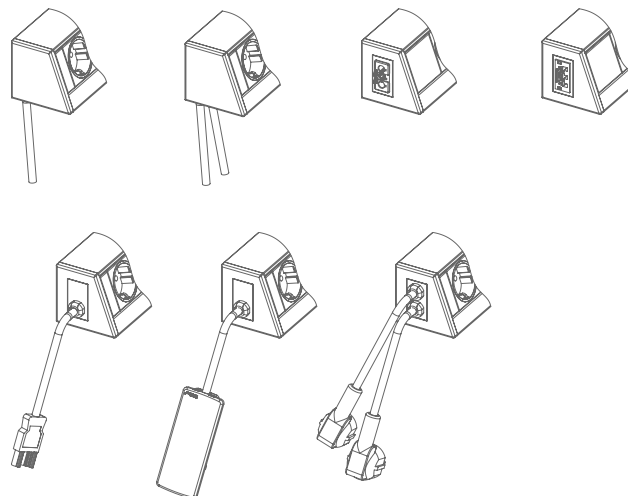
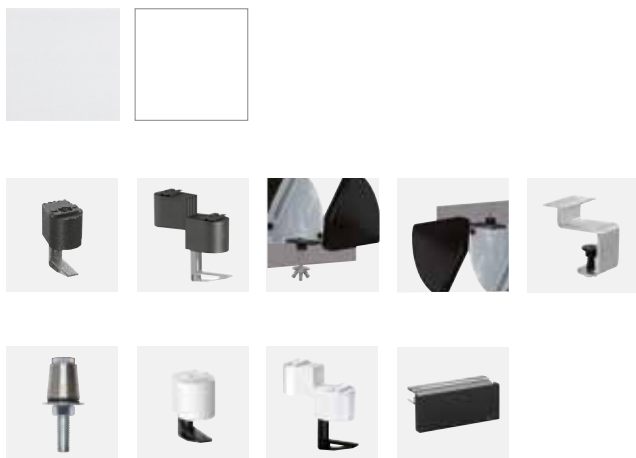

Become a co-designer and configure your very own EVoline R-Dock. Select from various finishes and modules for power, data, multimedia, safety and fixings.

Directly to
 EVoline
 Configurator.

[www.evoline.com/
 konfigurator](http://www.evoline.com/konfigurator)

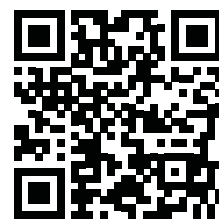

EVOLine® U-Dock





EVOLine® U-Dock

EVOLine U-Dock can be installed in various ways in a work surface.

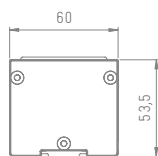
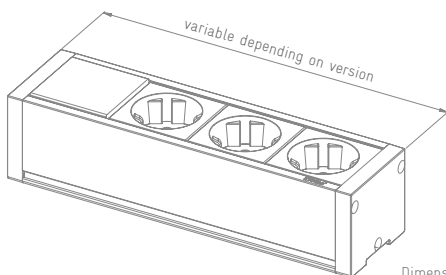
As a robust base for a professional power and data supply, the freely configurable aluminium profile can be equipped with various power and data connections as well as safety modules for the protection of personnel and machinery.



Dimensions in mm

Description	Picture	Specification	Order number
<p>EVoline U-Dock SMALL Aluminium housing, three sockets, VDE-compliant, 60°, 16 A, contact-protected. Power input / output in the end cap, with GST18 / 3 input plug and GST 18 / 3 output socket.</p>		<p>silver anodised with mounting tabs</p>	<p>1596 0000 9500</p>
<p>EVoline U-Dock DATA SMALL Aluminium housing, three sockets, VDE-compliant, 60°, 16 A, contact-protected. Power input / output in the end cap, with GST18/3 input plug and GST18/3 output socket. Two modular couplings RJ45 to RJ45 CAT6 shielded, 1:1 interconnected. Entry for data cables in the opposite end cap.</p>		<p>silver anodised with mounting tabs</p>	<p>1596 0000 5900</p>
		<p>silver anodised without mounting tabs</p>	<p>1596 0000 3300</p>

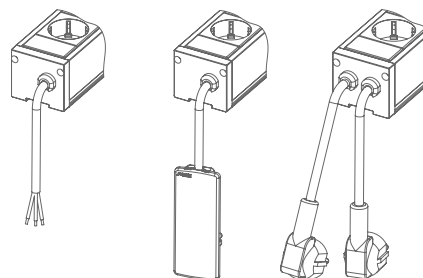
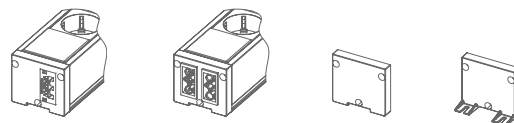

Become a co-designer and configure your very own EVoline U-Dock. Select from various finishes and modules for power, data, multimedia and safety.

Directly to
EVoline
Configurator.
[www.evoline.com/
konfigurator](http://www.evoline.com/konfigurator)

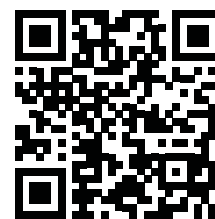

EV0line® V-Dock



Convenient.

EV0line® V-Dock

With EV0line V-Dock dead corners are put to work. V-Dock can be installed horizontally or vertically and is variable in length. As additional benefit, the supply cable is concealed using the space between the back of the profile and the wall corner. Thanks to the V-Docks 45 degree alignment power and data cables are easy to connect.

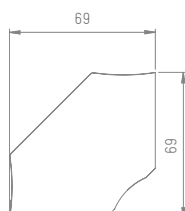
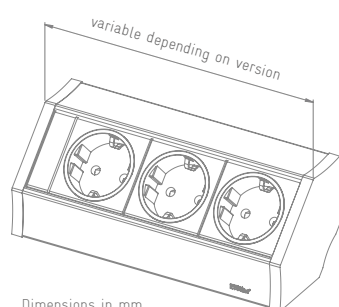
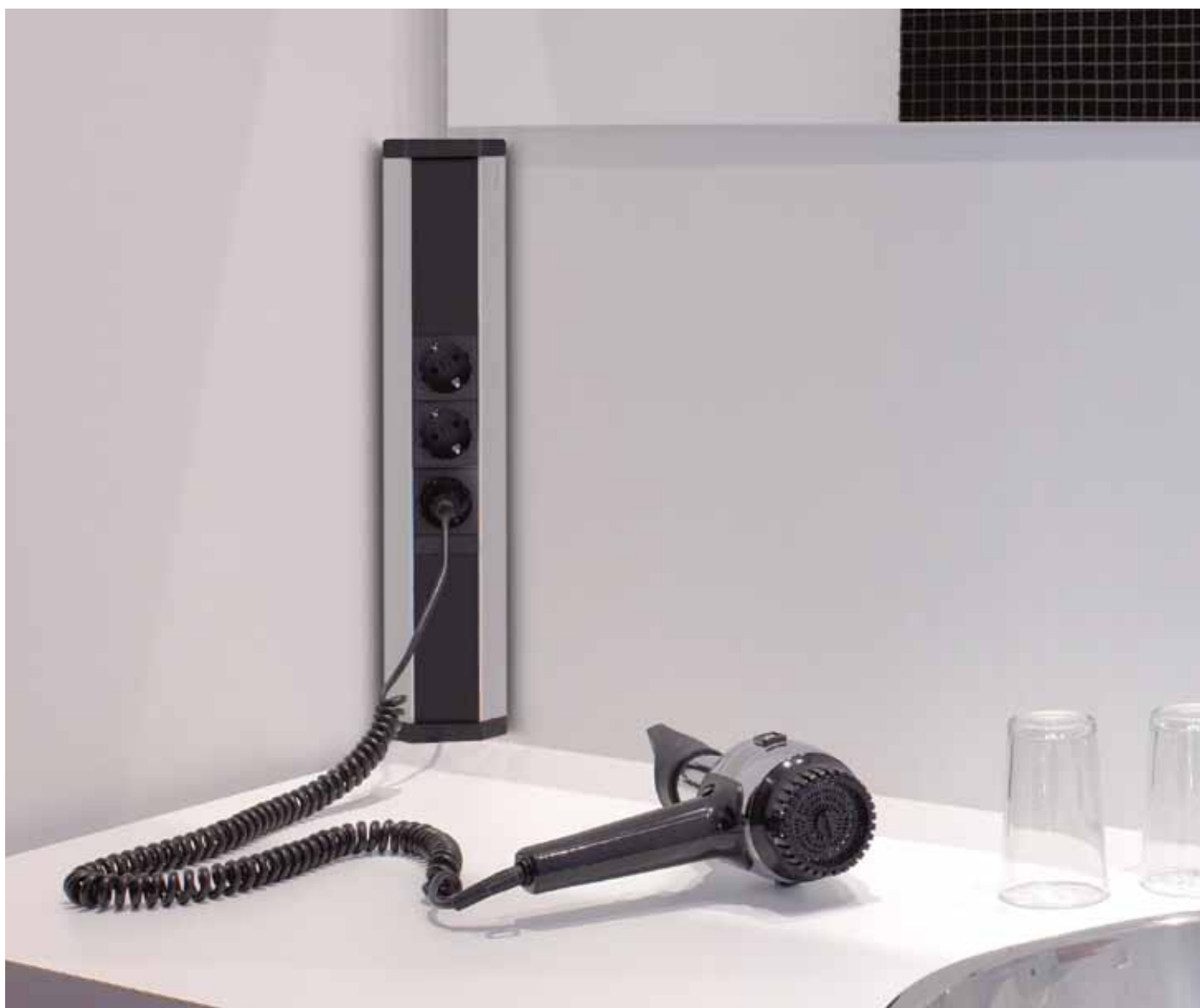

Dimensions in mm

Description	Picture	Specification	Order number
-------------	---------	---------------	--------------

EVoline V-Dock CUISINE
 Aluminium housing, three sockets, VDE-compliant, 0°, 16 A, contact-protected.
 Fixed supply cable 2.5 m with wire end ferrules, plug supplied unattached.

 With profile bracket 100 mm.



silver anodised 1593 6000 1300

EVoline V-Dock DATA SMALL
 Aluminium housing, three sockets, VDE-compliant, 0°, 16 A, contact-protected.
 Fixed supply cable 3.0 m with plug.
 Two modular couplings RJ45 to RJ45 CAT6 shielded, 1:1 interconnected.

 With two profile brackets 100 mm.



silver anodised 1593 6000 2300

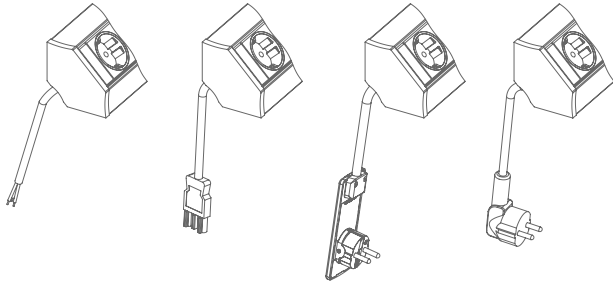

Become a co-designer and configure your very own EVoline V-Dock. Select from various finishes and modules for power, data, multimedia and safety.

Directly to
 EVoline
 Configurator.

[www.evoline.com/
 konfigurator](http://www.evoline.com/konfigurator)

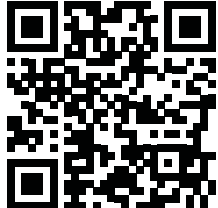



EV0line® T-Dock



At home in the kitchen.



EVoline® T-Dock

A solid stainless steel pillar raises the EVoline T-Dock up above the work surface. This gives clutter free work place and creates a safe distance between power supply and potentially wet surfaces in the kitchen. In addition, the sockets are also equipped with contact protection.

Features:

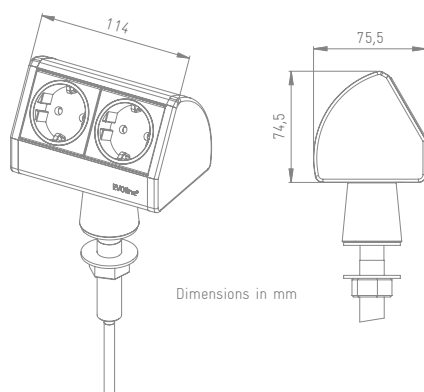
The stainless steel pillar through which the power supply cable runs to below the work surface is also a high quality anti-theft device since it is firmly screwed on beneath the surface.



Description	Picture	Specification	Order number
<p>EVoline T-Dock Aluminium housing in stainless steel optics, ALANOX. For mounting in work surfaces with a thickness of up to 40 mm. Two sockets, VDE-compliant, 0°, 16 A, contact-protected. Fixed supply cable with wire end ferrules, plug supplied unattached. Power supply cable entry through the pillar made of stainless steel.</p>		<p>black lacquered plastic end caps 1593 0220 5600</p> <p>plastic end caps lacquered in in stainless steel optics, ALANOX 1593 0345 5600</p>	
<p>EVoline T-Dock mit USB Charger* Aluminium housing in stainless steel optics, ALANOX. For mounting in work surfaces with a thickness of up to 40 mm. One socket, VDE-compliant, 0°, 16 A, contact-protected. Fixed supply cable with wire end ferrules, plug supplied unattached. Power supply cable entry through the pillar made of stainless steel.</p> <p>1x USB Type A Charger - ideal for charging of USB-chargeable devices, i.e. Apple (iPhones, iPads, iPods**), Tablets, Smart phones , MP3 Players. The USB charging function cannot be guaranteed due to the multitude of manufacturers and devices on the market.</p> <p>**TM Apple Computer Inc.</p>		<p>black lacquered plastic end caps 1593 0387 4600</p> <p>plastic end caps lacquered in in stainless steel optics, ALANOX 1593 0387 5600</p>	

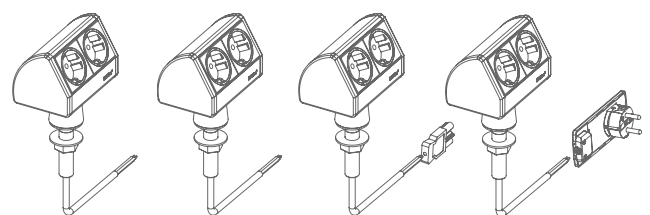

Become a co-designer and configure your very own EVoline T-Dock. Select from various modules for power and data.

Directly to
 EVoline
 Configurator.
[www.evoline.com/
 konfigurator](http://www.evoline.com/konfigurator)

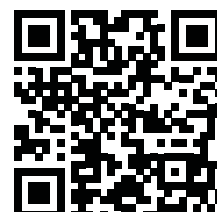

EV0line® Vertical



Stable. Spacesaving.

EV0line® Vertical

EV0line Vertical is a free standing solution, for any room. Securely fixed to a solid cast iron base, the Vertical is upright, mobile, and space saving and is the ideal solution for offices, hotels or retail areas.

The maximum height of 1.20 m makes it unnecessary to bend over to reach sockets: Power, data and multimedia connectors are available at a convenient height.

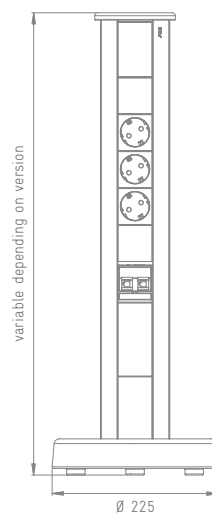

Dimensions in mm

Description	Picture	Specification	Order number
<p>EVoline Vertical Standard Aluminium housing, free standing, base made of solid cast iron, black powder coated. Three sockets, VDE-compliant, 60°, 16 A, contact-protected. Fixed supply cable, 3.0 m with plug. Two modular couplings RJ45 to RJ45 CAT 6 shielded, 1:1 interconnected. Cover made of aluminium, black powder coated. Dimensions: base diameter ø 24,5 cm, height: 4 cm, profile height: 600 mm.</p>		<p>silver anodised black anodised</p>	<p>1593 4300 1100 1593 4300 5000</p>



Become a co-designer and configure your very own EVoline Vertical. Select from various finishes, power connectors and modules.

Directly to
 EVoline
 Configurator.
[www.evoline.com/
 konfigurator](http://www.evoline.com/konfigurator)

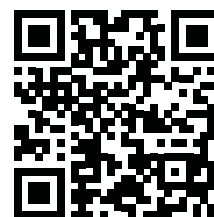

EV0line® Caddy





Wheeled. Custom-made.

EVoline® Caddy

EVoline Caddy gives new meaning to the concept of mobile connectivity. The customised solution with an aluminium roller case can be taken to wherever you need to work.

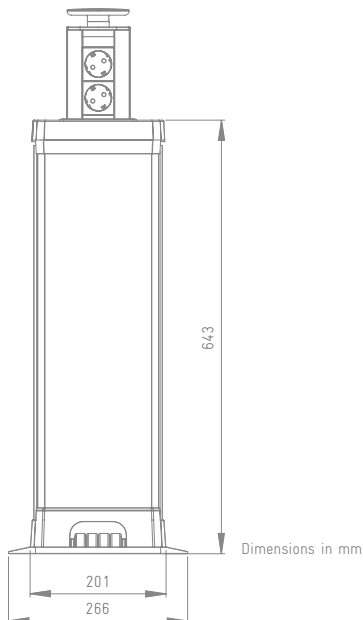
Caddy has an integrated EVoline Port providing options for power, data, and multimedia modules. In addition there is plenty of room within the Caddy case to organise and hide away all cables.



Description	Picture	Specification	Order number
<p>Empty housing EVoline Caddy Aluminium housing, silver anodised. Base plate made of black plastic with integrated rollers. Top panel made of black plastic. 1 x GST 18 input (plug) 1 x GST 18 output (socket) for integrated EVoline Port. One additional GST18 output (socket).</p> <p>Built in:</p> <p>Empty EVoline Port, aluminium housing, silver anodised. Collar in black lacquered plastic.</p>		<p>rocking cover and collar made of silver lacquered plastic</p> <p>rocking cover made of solid stainless steel in CD design</p>	<p>9330 3490 0000</p> <p>9330 3510 0000</p>

Become a co-designer and configure your very own EVoline Port for usage in the EVoline Caddy. Select from various finishes and connection modules.

Directly to
 EVoline
 Configurator.
[www.evoline.com/
 konfigurator](http://www.evoline.com/konfigurator)



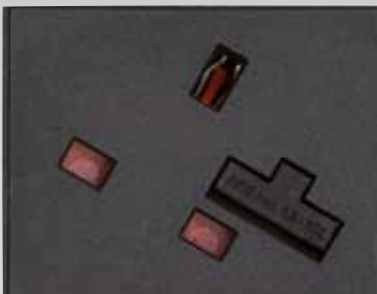
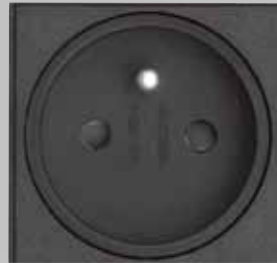
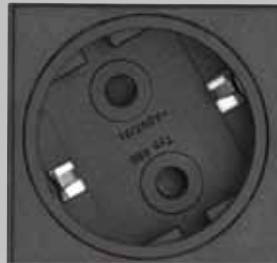

EV0line® Modules









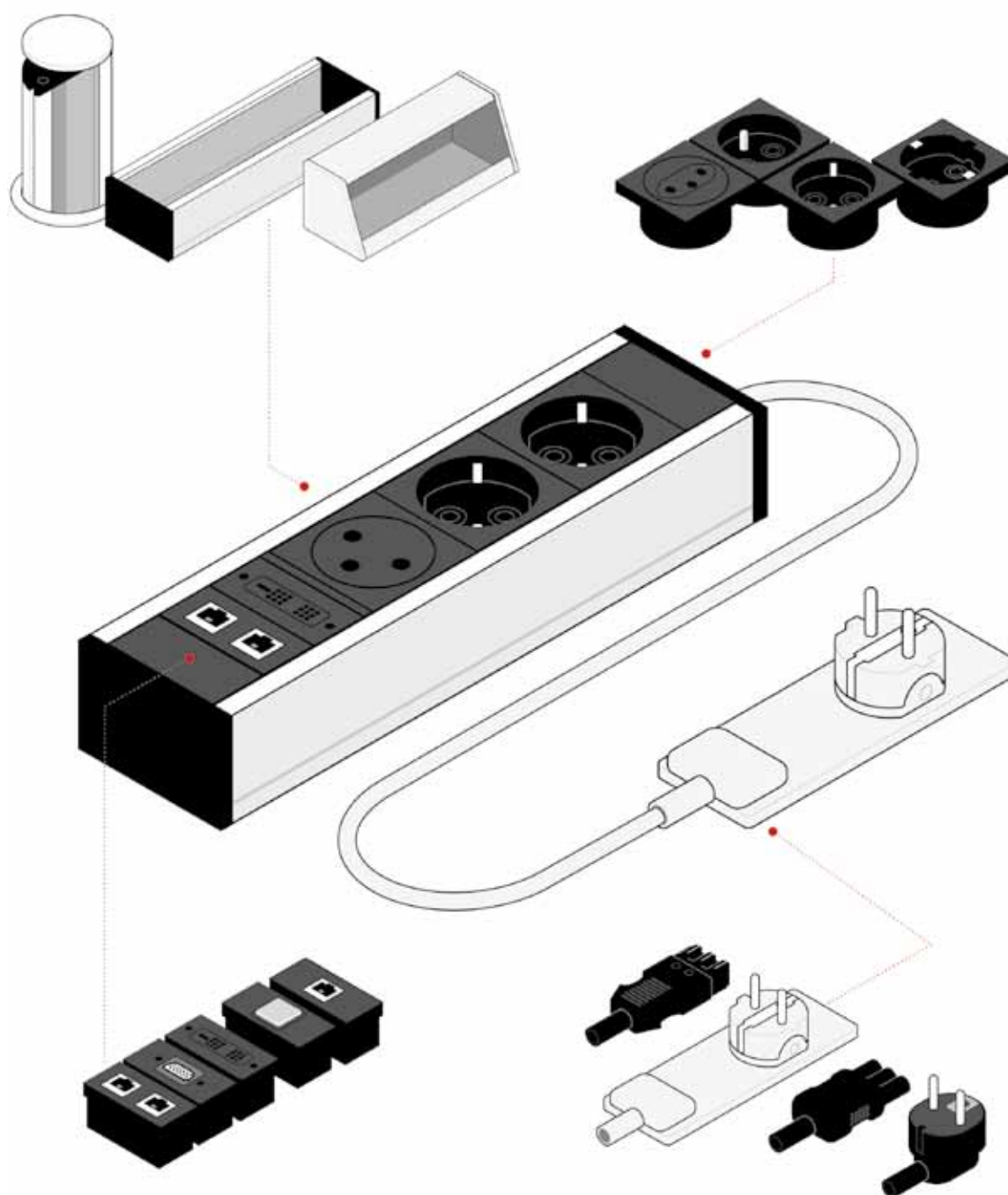

Endless possibilities.

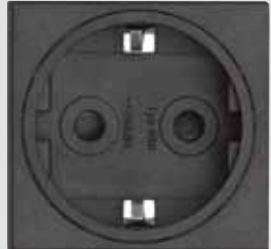
EV0line[®] Modules

EV0line systems can be configured to individual needs with a wide range of modules available - there is no general solution for the supply of e-connectivity. The following pages show a selection of power, data and protection modules.

Find the full range of modules in the [EV0line configurator](#).









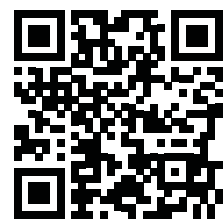

Description	Picture	Description	Picture
<p>Socket 0°, 16 A VDE-compliant, with or without contact protection, installation dimensions: 50 x 50 mm, for plug types: F, C, E+F</p>		<p>Socket 60°, 16 A VDE-compliant, with or without contact protection, installation dimensions: 50 x 50 mm, for plug types: F, C, E+F</p>	
<p>Socket 0°, 16 A with contact protection, i.e. France, Belgium, Poland, installation dimensions: 50 x 50 mm, for plug types: E, C, E+F</p>		<p>Socket 60°, 16 A with contact protection, i.e. France, Belgium, Poland, installation dimensions: 50 x 50 mm, for plug types: E, C, E+F</p>	
<p>Socket 0°, 10 A without contact protection, i.e. Switzerland, installation dimensions: 50 x 50 mm, for plug types: J, C, T13</p>		<p>Socket 0°, 16 A without contact protection, i.e. Switzerland, installation dimensions: 50 x 50 mm, for plug types: J, C, T13</p>	
<p>Socket 0°, 13 A with contact protection, i.e. Denmark, standard, installation dimensions: 50 x 50 mm, for plug types: K, C</p>		<p>Socket 0°, 13 A with contact protection, i.e. Denmark, EDP-coded, installation dimensions: 50 x 50 mm, for plug types: K</p>	
<p>Socket 0°, 10 A/16 A with contact protection, i.e. Italy, installation dimensions: 25 x 50 mm, for plug types: L, C</p>			

Find the full range of country-specific socket modules in EVoline Configurator.

Directly to
EVoline
Configurator.
[www.evoline.com/
konfigurator](http://www.evoline.com/konfigurator)



EVOLine® Sockets

Description	Picture	Description	Picture
<p>Socket 90°, 13 A i.e. UK, installation dimensions: 75 x 50 mm, for plug type: G</p>		<p>Socket 90°, 13 A With contact protection, i.e. UK, with integrated fuse, 3.15 A or 5 A, installation dimensions: 75 x 50 mm, for plug type: G</p>	
<p>Socket 30°, 13 A i.e. UK, installation dimensions: 60 x 50 mm, for plug type: G</p>		<p>Socket 30°, 13 A With contact protection, i.e. UK, with integrated fuse, 3.15 A or 5 A, installation dimensions: 60 x 50 mm, for plug type: G</p>	
<p>Socket 0°, 10 A Without contact protection, i.e. Australia, installation dimensions: 50 x 50 mm, for plug type: I</p>		<p>Socket 0°, 10 A Without contact protection, i.e. Australia, installation dimensions: 50 x 50 mm, for plug type: I / China</p>	
<p>Socket 0°, 15 A Without contact protection, i.e. USA, Canada, installation dimensions: 50 x 50 mm, for plug type: B (NEMA, 5-15)</p>		<p>Socket 0°, 15 A Angled outlet, without contact protection, i.e. USA, Canada, installation dimensions: 75 x 50 mm, for plug type: B (NEMA, 5-15), not for angled plugs</p>	

Description

Picture

Description

Picture

Socket 0°, 16 A

With contact protection, i.e. Israel, installation dimensions: 50 x 50 mm, for plug types: H, C



Connector 16 A

(Wieland) Socket GST18 Snap-In, for electrical current output, installation dimensions: 25 x 50 mm



Connector 16 A

WAGO WINSTA MIDI Socket WAGO WINSTA Snap-In, for electrical current output, Installation dimensions: 25 x 50 mm



USB Charger*

USB Type A Charger, charging function only. Ideal for charging of USB-chargeable devices.
 Rated supply voltage: 100-240 V AC +/- 10%
 No-load power consumption at 230 V AV <= 0,1 Watt
 Output voltage: 5V DC +/- 5%
 Rated output current: 1000 mA
 Installation dimension: 25 x 50 mm







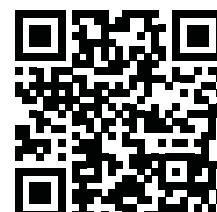

Find the full range of charging modules in EVOLine Configurator.

Directly to
 EVOLine
 Configurator.

[www.evoline.com/
 konfigurator](http://www.evoline.com/konfigurator)

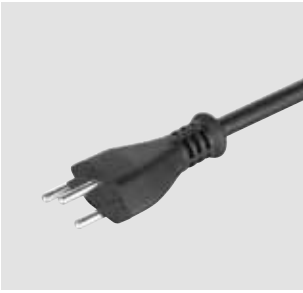

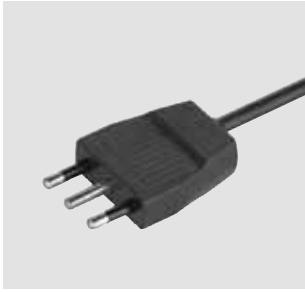
EVOLine® Power Supply Modules

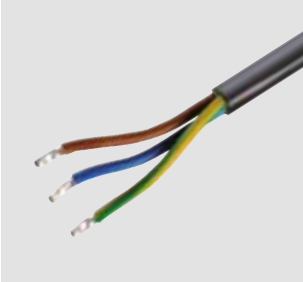
Description	Picture	Description	Picture
<p>Power Supply Module EVOLine PlugFix, VDE-compliant with cable. Type E+F, 16 A, 3x1.5 mm². Plug with extra low profile and movable plug face. Plug cannot be removed from the cable.</p>		<p>Power Supply Module With cable and right-angle plug type E+F 16 A, 3 x 1,5 mm², VDE-compliant, i.e. France, Belgium, Poland</p>	
<p>Power Supply Module With cable and plug Type J, T13, T23, 3 x 1,5 mm², i.e. Switzerland, 10 A / 16 A</p>		<p>Power Supply Module With cable and right-angle plug Type G 13 A, 3 x 1,5 mm², i.e. Great Britain</p>	
<p>Power Supply Module With cable and right-angle plug Type K, 13 A, 3 x 1,5 mm², i.e. Denmark, Standard</p>		<p>Power Supply Module With cable and plug Type L 16 A, 3 x 1,5 mm², i.e. Italy</p>	
<p>Power Supply Module With cable and plug type B, 115 V, 15 A, AWG 14, i.e. USA, Canada (UL/CSA)</p>			
<p>Power Supply Module With cable and wire-end ferrules, 16 A, 3 x 1,5 mm²</p>			

Description

Picture

Description

Picture

Power Supply Module
 Plug GST18 with cable,
 16 A, 3 x 1,5 mm²



Power output
 Socket GST18 with cable,
 16 A, 3 x 1,5 mm²



Connector 3-pole
 Wieland, Snap-In,
 installed in the end cap,
 plug GST18,
 socket GST18,
 colour: black

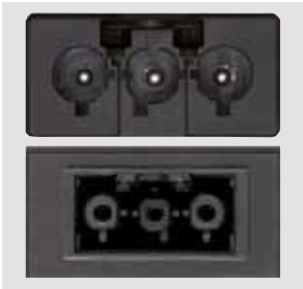

Connector 3-pole
 WAGO WINSTA MIDI
 Snap-In,
 installed in the end cap,
 plug WAGO WINSTA MIDI,
 socket WAGO WINSTA MIDI
 colour: black







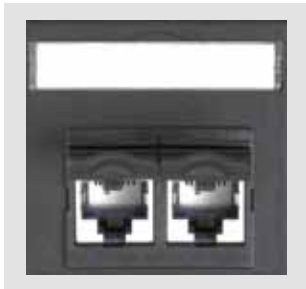

More power supply modules
 available in our
 EVoline Configurator.

Directly to
 EVoline
 Configurator.
[www.evoline.com/
 konfigurator](http://www.evoline.com/konfigurator)



EVOLine® Data Modules / Modular Adaptors

Description	Picture	Description	Picture
Data Plate with Two Snap-In Data Sockets RJ45 CAT6, CAT6_A / GG45 / CAT7 , with labelling field, installation dimensions: 50 x 50 mm		Data Plate with Two Snap-In Data Sockets RJ45 CAT6, CAT6_A / GG45 / CAT7 , with labelling field, installation dimensions: 50 x 50 mm	
Data Plate with One Snap-In Data Socket RJ45 CAT6 / CAT6_A , Installation dimensions: 25 x 50 mm, with 3.0 m cable and plug RJ45			
Data Plate with One Modular Adaptor RJ45 to RJ45 CAT6, CAT6_A , one-to-one connection, for patch cable Installation dimensions: 25 x 50 mm		Data Plate with Two Modular Adaptors Angled outlet with labelling field, RJ45 auf RJ45 CAT6, CAT6 _A , one-to-one connection, for patch cable, installation dimensions: 50 x 50 mm	
Data Plate with Two Modular Adaptors ELBRO Angled at 90 degree RJ45 to RJ45 CAT6, CAT6 _A , one-to-one connection, for patch cable Installation dimensions: 25 x 50 mm			
			

Active EVOLine® Gigabit Ethernet Components, SNMP-manageable







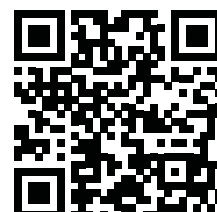

Description	Picture
<p>Data Plate LAN Switch 6 Port Gigabit Ethernet Switch , Microsens</p> <p>4 x 10/100/1000Base-T plus 2 x 10/100/1000Base-T 4 x 10/100Base-Tx plus 2 x 10/100Base-Tx Integrated power supply 110/230 V SNMP-manageable, VLANs with logical separation (network management, Voice over IP, internet connection)</p> <p>Optional: PoE (Power over Ethernet) PoE+ (Power over Ethernet +) LWL-Uplinks (fibre optic cable)</p> <p>Installation dimensions: 150 x 50 mm</p>	

Additional data modules
available via our
EVOLine Configurator.



Directly to
EVOLine
Configurator.
[www.evoline.com/
konfigurator](http://www.evoline.com/konfigurator)



EVOLine® Multimedia Modules Analogue / Digital

Description	Picture	Description	Picture
VGA Connector 15-contact HDD socket, with screw-in connector, halogen free / flame resistant cable, installation dimensions: 25 x 50 mm		Audio Port, 1 x Stereo jack socket 3.5 mm with cable and high quality plug, installation dimensions: 25 x 50 mm	
DVI-D Port 18-contact DVI socket single link, halogen free / flame resistant cable, for digital signals only, installation dimensions: 25 x 50 mm		HDMI Port, HDMI 1.4 socket With gold plated contacts, optimum performance through high-quality flat cable, installation dimensions: 25 x 50 mm	
Display Port Connector Display Port socket, with lock, DP 1.2 compliant, with UL approval, installation dimensions: 25 x 50 mm		USB 3.0 Port 1 x USB 3.0 type B socket on type B plug, data rate up to 5 Gbit/s, installation dimensions: 25 x 50 mm	
USB 2.0 Port 1 x USB 2.0 type A socket for connection of USB standard consumer devices, installation dimensions: 25 x 50 mm		USB 3.0 Port 1 x USB 3.0 type A socket for connection of USB standard consumer devices, data rate up to 5 Gbit/s, installation dimensions: 25 x 50 mm	

EVoline® Cable Management for Multimedia and Data

Description	Picture
<p>Cable Conduit Module Cable passage Cable can be pulled out through the bushing is retractable after use. Ø 8mm / Ø 12mm / Ø 17mm Colour: Black Installation dimensions: 50 x 50 mm</p>	
<p>Cable Guide Module Holder for three cables Ø 2 x 8mm, 1 x 12 mm Cables can be pulled out through the bushing and is retractable after use. Colour: Black Installation dimensions: 25 x 50 mm</p>	

Additional multimedia modules available in our EVoline Configurator.

Directly to
EVoline
Configurator.

[www.evoline.com/
konfigurator](http://www.evoline.com/konfigurator)

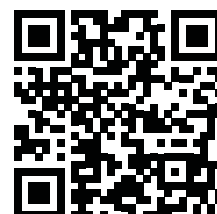

EVOLine® Switches / Pushbuttons / Kinetics Modules

Description	Picture	Description	Picture
<p>Switch, 230 V~, 2-pole Illuminated in blue, for various functions, for example switching of:</p> <ul style="list-style-type: none"> - built-in sockets, - design lighting, - external sources via separate power cable, <p>installation dimensions: 50 x 50 mm</p>		<p>Master/Slave 2-pole, Controls downstream sockets (slave sockets). Available only as combination of upstream master and downstream slave socket. Corresponding sockets required.</p> <p>Switching threshold: adjustable from 20 to 100 mA, rated voltage: 250 V, rated current: 16 A, 2-pole, with protective contact, protection class IP20, slave-circuit: 2-pole, installation dimensions: 75 x 50 mm</p>	
<p>Pushbutton, 1x Closing contact, 1-pole Series 18, (eao) Switching capacity max. 42 V AC/DC, 100 mA, lens dimension: 14 x 14 mm, lens colour: grey, installation dimensions: 25 x 50 mm Frame: black</p>		<p>Pushbutton, 2x Closing contact, 1-pole Series 18, (eao) Switching capacity max. 42 V AC/DC, 100 mA, lens dimension: 14 x 14 mm, lens colour: grey, installation dimensions: 25 x 50 mm Frame: black</p>	
<p>Pushbutton, 4x Closing contact RS232 or KNX, 1-pole Switching capacity max. 42 V AC/DC, 100 mA, Potential-free 4x pushbutton, LED illuminated. LED supply voltage adjustable from 0 to 48 V. Connection via screw terminals. Installation dimension: 50 x 50 mm Frame: black</p>			
<p>EVOLine Kinetics - switching without power supply</p>			
<p>Kinetics Wireless Transmitter, Built-in module to switch on/off. Controls all receivers of the EnOcean Alliance. Range up to 30 m. Installation dimension: 50 x 50 mm</p>			
<p>Kinetics Wireless Transmitter, Module with frame to switch on/off. Controls all receivers of the EnOcean Alliance. Range up to 30 m. Dimensions: 60 x 65 mm</p>		<p>Kinetics Wireless receiver, 2-pole module, switching states: ON/OFF, with display switching status, green, 230 V~ actuator with switching capacity of max. 16 A. Switches devices such as lights. For EnOcean Alliance transmitters. Installation dimensions: 75 x 50 mm</p>	



Description

Picture

Description

Picture

Residual Current Device

RCD / RCCB
2-pole, characteristics B,
type A
Frame: black,
installation dimensions:
100 x 50 mm,
rated current:
10A / 13A / 16A



Circuit Breaker

MCB
2-pole, characteristics B
Frame: black
Installation dimensions:
100 x 50 mm
Rated current:
10A / 13A / 16A



Surge Protector

Operating area max. 5 m distance
in all directions from surge
protection module.
Optical indicator when surge pro-
tection module was triggered.
(green LED lit)
Tested according to
DIN/VDE 0675, Part 6
Class D fine protection
Rated leakage current 1,5 kA
Maximum leakage current 5 kA
Installation dimensions:
50 x 50 mm



Overload Circuit Breaker

Required for 3 sockets or more
in USA, Canada, and Australia.
Available only with sockets.
1-pole,
Type: Sliding switch
Installation dimensions:
25 x 50 mm



Compressed Air Connector Module

3 sockets FESTO KD4
(Nominal diameter 7,2)
1 plug FESTO KS4
(in the end cap)
Includes matching end cap
For workplaces in laboratories
and workshops
Installation dimensions:
100 x 50 mm



Additional protection and special
modules available in our
EVoline Configurator.

Directly to
EVoline
Configurator.

[www.evoline.com/
konfigurator](http://www.evoline.com/konfigurator)

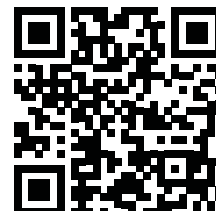

EVoline® Express



EVoline® Express

EVoline Express Type 910 for a consistent modular power supply – modular from the number of power sockets, international sockets, protection and safety modules, to various special switches.

Various colours available.



Socket modules 2 x to 4 x

Self-extinguishing plastic

Tested and coded individually.



International sockets

Switch

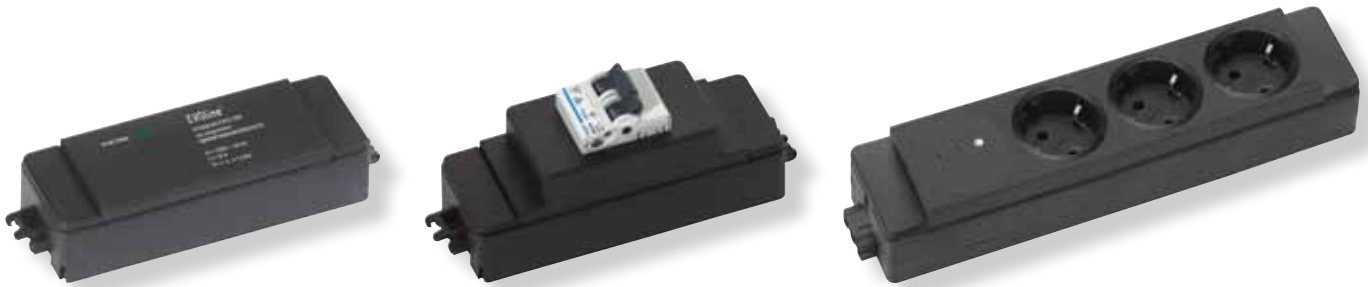

Protection and safety modules

Remote controlled via integrated EVoline Kinetics receiver module (system EnOcean)



Power in- and output via connectors

Wieland GST 18i13

WAGO Winsta MIDI

Power supply cable with EVoline Plug or right-angle plug

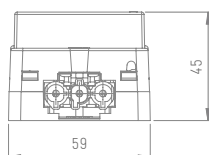
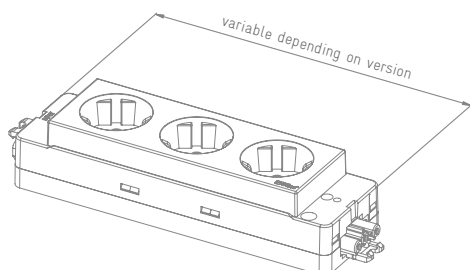

Dimensions in mm

Description	Picture	Specification	Order number
<p>EVoline Express 2x power bar type 910 VDE-compliant, for plug types: F, E+F, C Rated voltage: 250 V / 50 Hz Rated current: 16 A</p> <p>Dimensions (W/H/L): 46 x 59 x 150 mm</p>		Wieland GST 18	
		Without contact protection	
		Housing colour black	1591 0200 0100
		Housing colour red	1591 0200 0120
		With contact protection	
		Housing colour black	1591 0200 0110
		Housing colour red	1591 0200 0130
		WAGO WINSTA MIDI	
		Without contact protection	
		Housing colour black	1591 0200 0200
		Housing colour red	1591 0200 0220
		With contact protection	
Housing colour black	1591 0200 0210		
Housing colour red	1591 0200 0230		
<p>EVoline Express 3x power bar type 910 VDE-compliant, for plug types: F, E+F, C Rated voltage: 250 V / 50 Hz Rated current: 16 A</p> <p>Dimensions (W/H/L): 46 x 59 x 200 mm</p>		Wieland GST 18	
		Without contact protection	
		Housing colour black	1591 0300 0100
		Housing colour red	1591 0300 0120
		With contact protection	
		Housing colour black	1591 0300 0110
		Housing colour red	1591 0300 0130
		WAGO WINSTA MIDI	
		Without contact protection	
		Housing colour black	1591 0300 0200
		Housing colour red	1591 0300 0220
		With contact protection	
Housing colour black	1591 0300 0210		
Housing colour red	1591 0300 0230		
<p>EVoline Express 4x power bar type 910 VDE-compliant, for plug types: F, E+F, C Rated voltage: 250 V / 50 Hz Rated current: 16 A</p> <p>Dimensions (W/H/L): 46 x 59 x 250 mm</p>		Wieland GST 18	
		Without contact protection	
		Housing colour black	1591 0400 0100
		Housing colour red	1591 0400 0120
		With contact protection	
		Housing colour black	1591 0400 0110
		Housing colour red	1591 0400 0130
		WAGO WINSTA MIDI	
		Without contact protection	
		Housing colour black	1591 0400 0200
		Housing colour red	1591 0400 0220
		With contact protection	
Housing colour black	1591 0400 0210		
Housing colour red	1591 0400 0230		

Additional country specific versions of EVoline Express Type 910 available in our EVoline Configurator.

Directly to
EVoline
Configurator.
[www.evoline.com/
konfigurator](http://www.evoline.com/konfigurator)

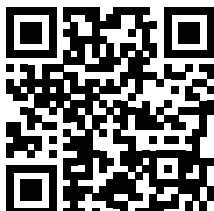

EVoline® Express Type 900 / 901 / 911

Description	Picture	Specification	Order number
<p>EVoline Express 3x power bar type 900, VDE-compliant, for plug types: F, E+F, C Rated voltage: 250 V / 50 Hz Rated current: 16 A Sockets without contact protection.</p> <p>Dimensions (W/H/L): 40 x 58 x 220 mm</p>		<p>Wieland GST 18</p> <p>Housing colour black Housing colour red</p>	<p>1590 0100 1500 1590 0100 1600</p>
<p>EVoline Express 3x power bar type 901, VDE-compliant, for plug types: F, E+F, C Rated voltage: 250 V / 50 Hz Rated current: 16 A Sockets without contact protection.</p> <p>Dimensions (W/H/L): 46 x 60 x 150 mm</p>		<p>Wieland GST 18</p> <p>Housing colour black Housing colour red</p> <p>Housing colour black With 200 mm earth lead</p> <p>Housing colour red With 200 mm earth lead</p>	<p>1590 1100 1500 1590 1100 1600</p> <p>1590 1100 3500 1590 1100 3600</p>
<p>EVoline Express 3x power bar type 911, UK, with on/off switch and contact protection.</p> <p>Dimensions (W/H/L): 39 x 58 x 186 mm</p>		<p>Wieland GST 18</p> <p>Housing colour black Single fuse 3.15 A and ground terminal</p> <p>Housing colour red Single fuse 3.15 A and ground terminal</p>	<p>1591 1100 2500 1590 1100 2600</p>

EVoline® Express power supply modules

Description	Picture	Specification	Order number
EVoline Express Power Supply Cable VDE-compliant, with right-angle plug and socket connector. For plug types: E+F black		GST 18 3.0 m	6590 0603 0500
		WAGO WINSTA MIDI 3.0 m	6590 0903 0100
EVoline Express Connecting Cable with socket and plug connector black		GST 18 0.5 m	6590 0700 5500
		WAGO WINSTA MIDI 0.5 m	6590 0750 5100
		GST 18 2.5 m	6590 0702 5500
		WAGO WINSTA MIDI 2.5 m	6590 0752 5100

EVoline Express protection modules, power supply modules for various countries, as well as a large selection of accessories available via our EVoline Configurator.

Directly to
EVoline
Configurator.

[www.evoline.com/
konfigurator](http://www.evoline.com/konfigurator)

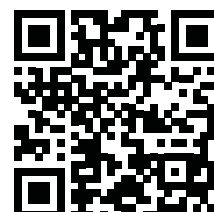

EV0line® Plug





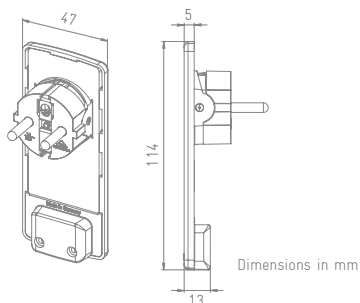

Extremely thin. Fits behind any cupboard or cabinet. Prevents tripping hazards.

EVoline® Plug

The ultra-low profile EVoline Plug easily fits behind any piece of furniture. Its intelligent joint mechanism transforms the handle into a lever – and the plug can be easily removed from the socket without the use of force. Even in case of a pull on the cable, the plug is released without damage. EVoline plug has won many awards for its smart ergonomics and minimalistic design.



Description	Picture	Specification	Order number
<p>EVoline Plug Screwable ultra-low profile grounded plug with movable plug face, for cable diameters of 0.75 mm² to 1.5 mm², 250 V / 16 A</p>		<p>black white</p>	<p>1510 0000 0100 1510 0000 0300  REG.-Nr. D345</p>
<p>EVoline Plug with cable 3 x 1.5 mm², cable length 1.5 m connected to 3 x power bar EVoline Express, 250 V / 16 A</p>		<p>black white</p>	<p>1510 0015 6100 1510 0015 6300</p>
<p>EVoline Plug with cable 3 x 1.5 mm², cable length 1.5 m connected to socket coupling with contact protection, 250V / 16 A</p>		<p>black white</p>	<p>1510 0015 5100 1510 0015 5300</p>
<p>EVoline Plug with cable 3 x 1.5 mm², cable length 1.5 m and connector. Select from Wieland GST18 or WAGO WINSTA sockets.</p>		<p>Wieland GST 18 black white WAGO WINSTA black</p>	<p>1510 0015 2100 1510 0015 2300 1510 0015 8100</p>

EV0line® Cable Management





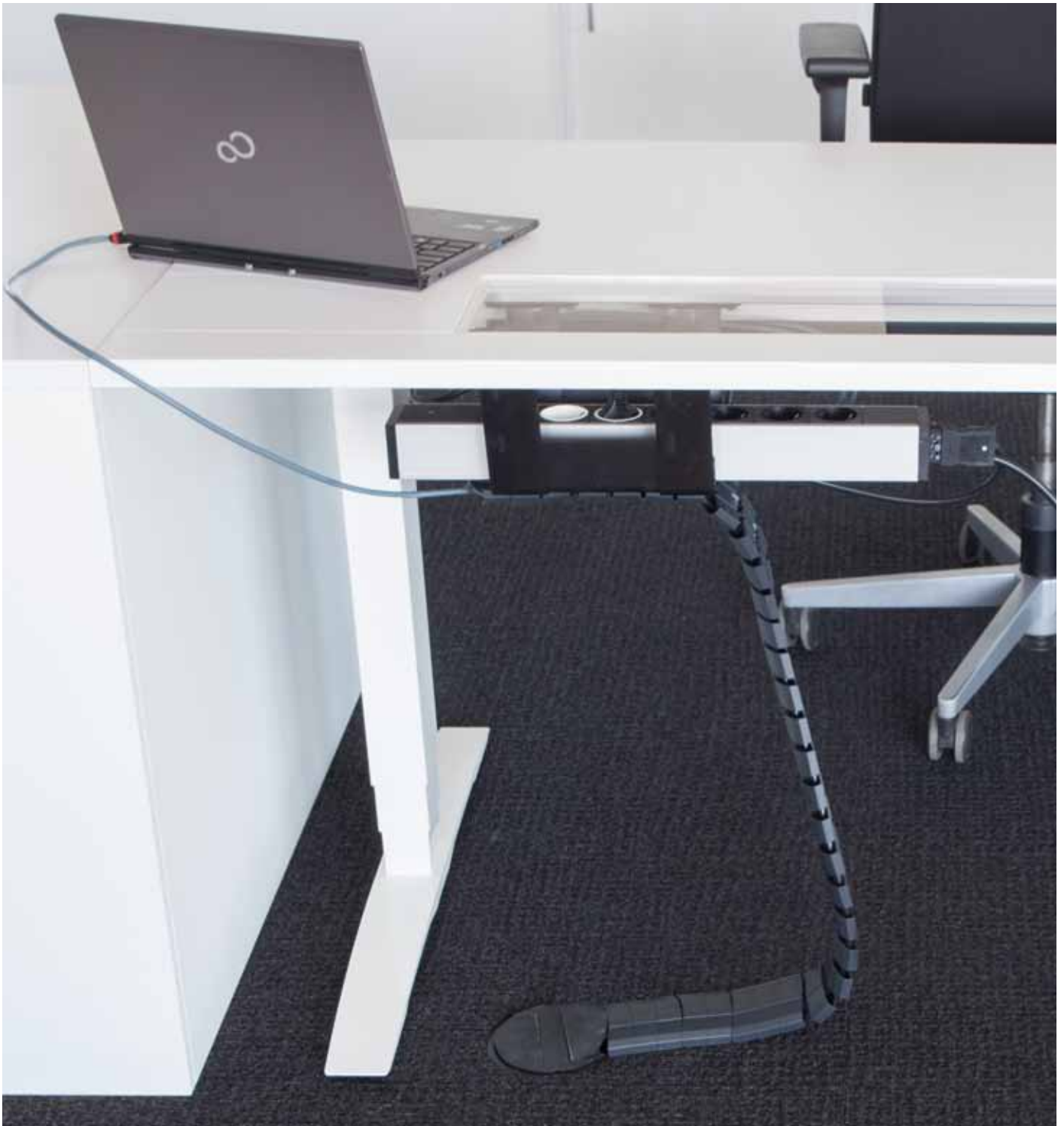

EV0line® Cable Management

EV0line Cable Management organises and consolidates loose cables and ensures health & safety requirements within office interiors. The Bridge-System enables individual solutions for almost any application. Connectors, 90° angled module, T-module and cross module allow cable routing on the floor as required. The vertical module is perfect for the clean transition between walls and furniture.

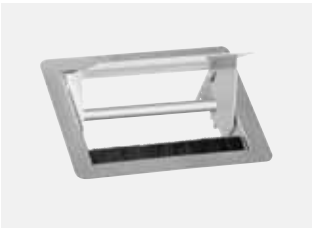
Furthermore, an adapter module is available for connection to EV0line WireLane.



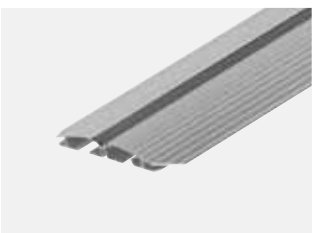



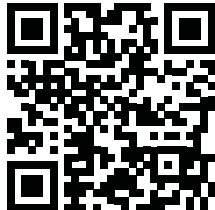

Description	Picture	Specification	Order number
<p>Cable Outlet EVoline FlipTop SMALL For installation in work surfaces with thickness of 19 to 35 mm. Fold out cover with click stops and end stops. Cable outlet with black brush strip. Installation dimensions: 185 x 157 mm</p>		<p>Housing and cover made of brushed stainless steel</p>	<p>1593 4204 0300</p>
<p>Cable Passage EVoline Port Rocking cover and collar made of plastic</p>		<p>silver lacquered black lacquered</p>	<p>1593 1002 5301 1593 1003 2601</p>
<p>Cable Passage EVoline Port Rocking cover made of solid stainless steel in CD-look and collar made of plastic, painted to match</p>		<p>solid stainless steel</p>	<p>1593 1003 2701</p>
<p>EVoline WireLane Under-desk cable channel made of plastic. One package consisting of 3 pieces, each 250-330 mm in length. The elements can be linked and separated.</p>		<p>black grey</p>	<p>6593 5201 0000 6593 5211 0000</p>
<p>EVoline Bridge Cable cover for screw fixing made of aluminium with black trim.</p>		<p>Includes 4 CableClips Length: 1.200 mm</p>	<p>1593 5011 2000</p>

For a wide range of modules for cable management see EVoline Configurator.

Directly to
 EVoline
 Configurator.
[www.evoline.com/
 konfigurator](http://www.evoline.com/konfigurator)

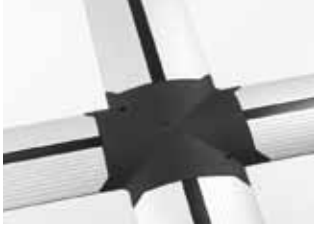

EVOLine® Cable Management

Description	Picture	Description	Picture
Bridge Module Arc 90° includes 4 fixing bolts		Bridge Module T includes 6 fixing bolts	
Bridge Module Cross includes 8 fixing bolts			
Bridge Module Adaptor WireLane can also be used as end piece		Bridge Module Vertical	
Bridge Connectors 2 pieces			

For a wide range of modules for cable management see the EVOLine Configurator.

Directly to
EVOLine
Configurator.

[www.evoline.com/
konfigurator](http://www.evoline.com/konfigurator)

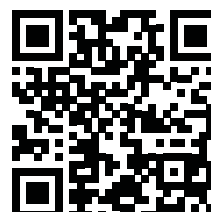

EV0line® Fixings / Accessories











EV0line[®] Fixings / Accessories

There is a variety of fixings and mounting accessories available for use with EV0line connectivity systems.

Whether for a simple power and data unit or a customised individual item the available options provide secure fixing solutions with effortless installation.



Description	Picture	Specification	Order number
<p>Mounting Clamp Twist-proof (includes non-slip covering) Colour: black</p> <p>For profiles: Dock, U-Dock, R-Dock</p>		<p>Mounting Clamp with add-on bracket, for installation of a second EVoline Dock, twist-proof (includes non-slip covering) Colour: Black</p> <p>For profiles: Dock, V-Dock, R-Dock, U-Dock</p>	
<p>Mounting Clamp Twist-proof (includes non-slip covering) Colour: white</p> <p>For profiles: Dock, U-Dock, R-Dock</p>		<p>Mounting Clamp with add-on bracket, for installation of a second EVoline Dock, twist-proof (includes non-slip covering) Colour: white</p> <p>For profiles: Dock, V-Dock, R-Dock, U-Dock</p>	
<p>EVoline Stainless Steel Mounting Clamp Twist-proof desk clamp for EVoline profiles Installed and secured with Allen screws.</p> <p>For profiles: Dock, U-Dock, R-Dock</p>			
<p>Mounting set for under cabinet installation Consists of two EVoline Dock brackets with wood screws.</p> <p>Screw size: 3,5 x 15 mm</p>		<p>Mounting set for desk installation Consisting of two Dock brackets with wing nut screws.</p> <p>Screw size: M4 x 40 mmm</p>	
<p>Stainless Steel Pillar High quality anti-theft device for EVoline Docks consisting of: Stainless steel sleeve, screw, nut, washer and rubber seal.</p> <p>For profiles: Dock, U-Dock, R-Dock</p>		<p>Additional installation modules and a wide range of accessories available in our EVoline Configurator.</p>	

Directly to
EVoline
Configurator.
[www.evoline.com/
konfigurator](http://www.evoline.com/konfigurator)

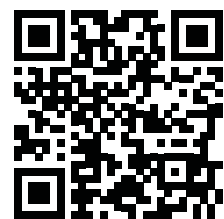

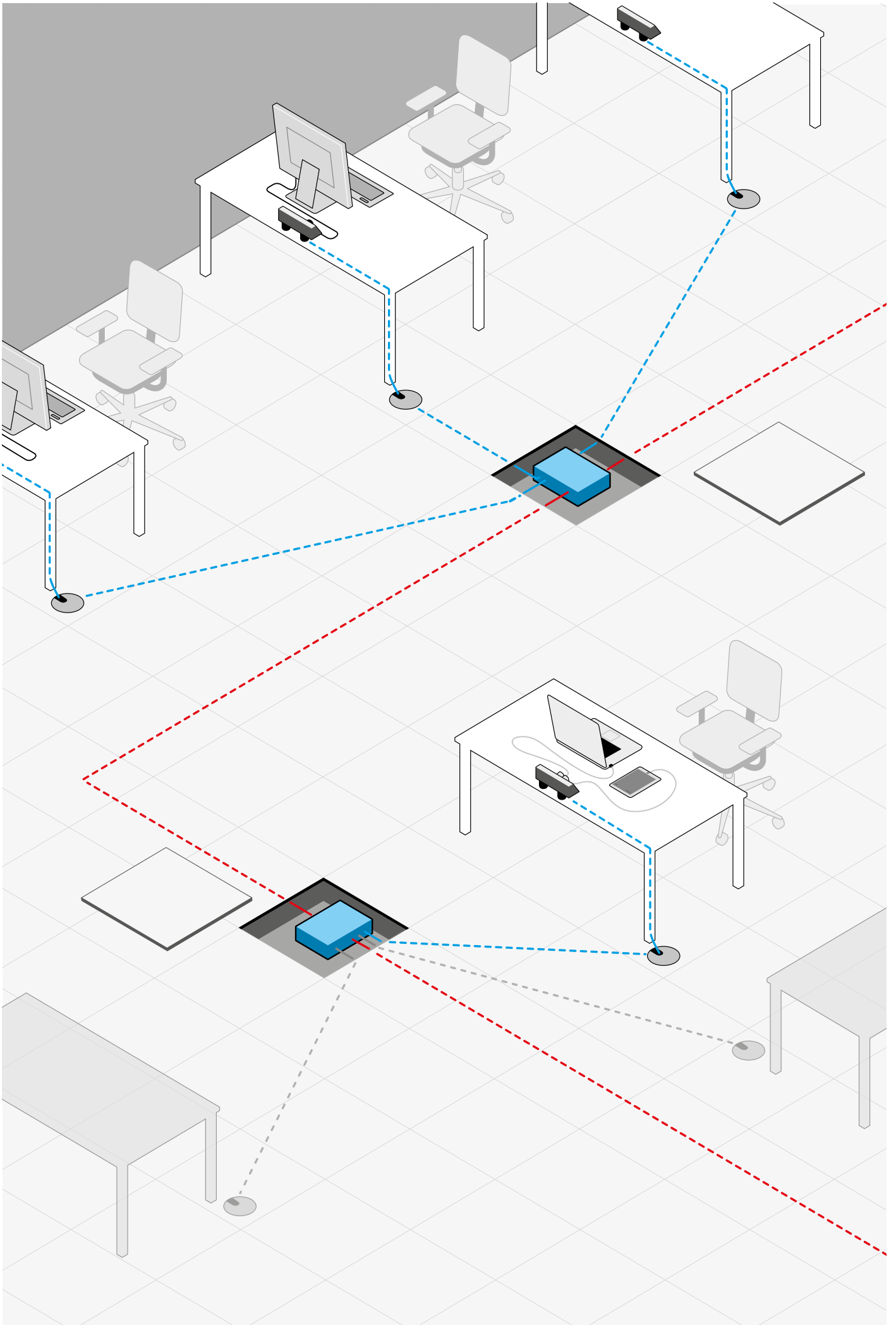

EV0line[®] Decentralised Electrical Distribution

EV0line Consolidation Points are decentralised distribution systems on a ring line which allow localized connection and protection of individual work groups. Protected circuits are installed only where connectivity is needed.

The benefits of Consolidation Points include a quick and flexible response to changes in the connectivity requirements change; reduced systems costs by 40 - 50% compared to traditional installation, and the fire load is also reduced by approximately 80%.

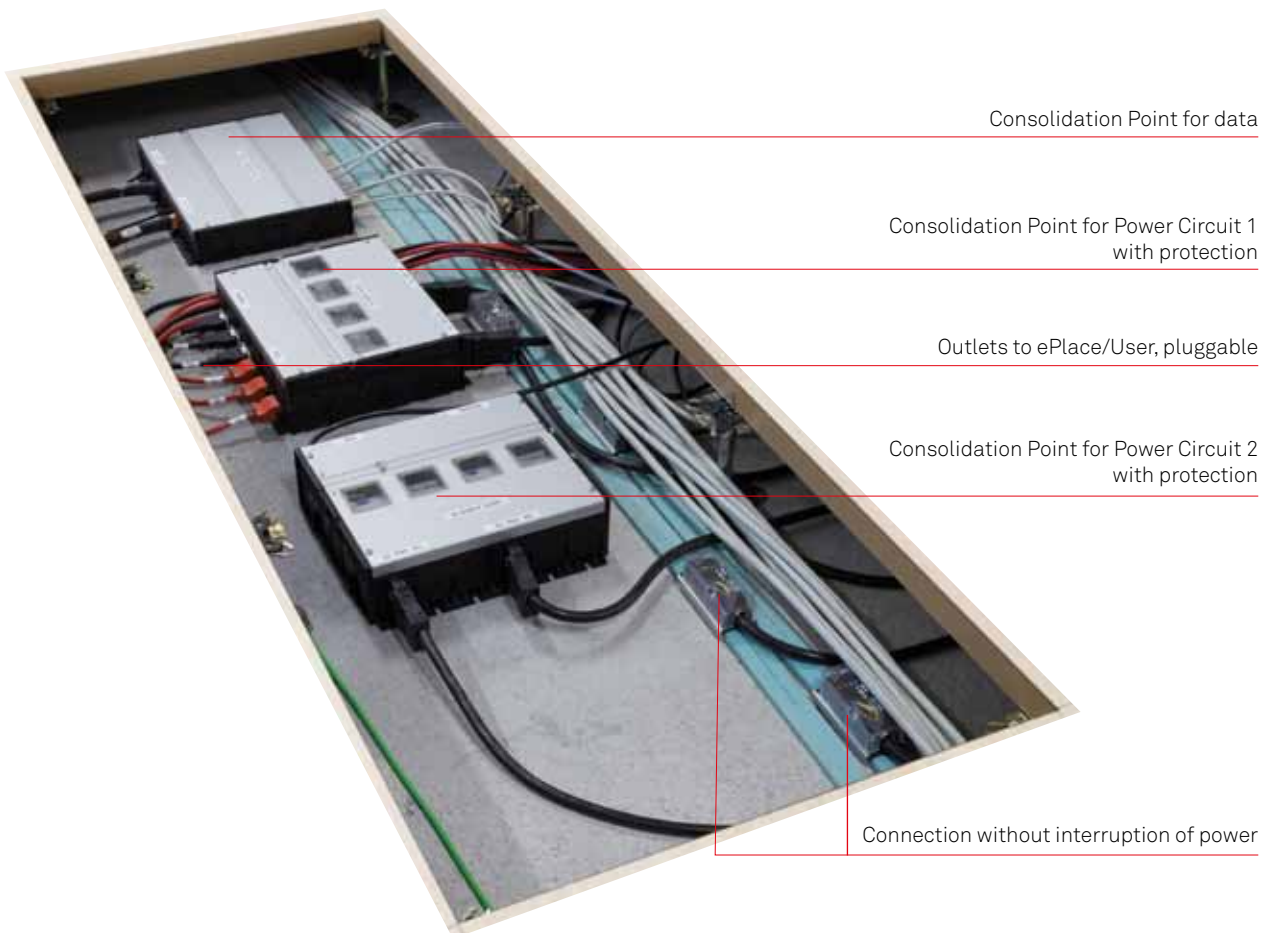

New Ways with EVOLine®

From entry of energy and data to ePlace and point of use.

We have questioned 100 years of electro-tradition:

- Central electrical cabinets with fuses, cut slits, bore holes, run cables to and back, install flush mount boxes, sockets, and switches, connect, plaster, finish, etc.

Our Approach:

Step 1

Cavity and double floors are standard in today's office buildings.

Step 2

Office space layouts change frequently (usually within three years according to research of Fraunhofer IAO) due to organizational changes, new tenants, etc. The value of a building is determined by highest degree of flexibility and shortest time for changes (Fraunhofer IAO.)

Step 3

Fixed installations are „out“, flexible and multifunctional installations are „in“! For our EVOLine Consolidation Point systems (CP) that means:

- Each room is equipped with just one single main ring line of 400 V, regardless of later layout or use. If necessary data lines as well.

Step 4

(see example plans A and B)

At first the layout is planned according to the envisioned use of the room.

Questions raised are:

Will the room/fire compartment be used as library, doctor's office, administration, open plan office, bank....?

Step 5

Detailed electrical planning:

- position Consolidation Points and equip them with adapters and switches for each work space.
- determine connection modules and floor outlets for each desk (ePlace.)
- select data and audio modules as well as light controls (e.g. via EVOLine Kinetics, EnOcean System.)

Step 6

The needs of the individual user determine installation of EVOLine connection and distribution systems (one or two computer monitors, audio connection yes/no, data network connection yes/no etc.)

We received the results of this approach from a number of representative office buildings with up to 4500 work places:

Savings at least 40%

Fire load reduction approximately 80%

And, very important, flexibility in case of change in use is included free of charge!

The environment is protected and becomes a beneficiary.

Not like this!

But like this!



At the time of moving into a representative new office building. Sub-floor boxes are installed in a grid pattern.

Photograph taken two weeks later.

EVoline floor outlet with EVoline WireLane placed according to layout plan.

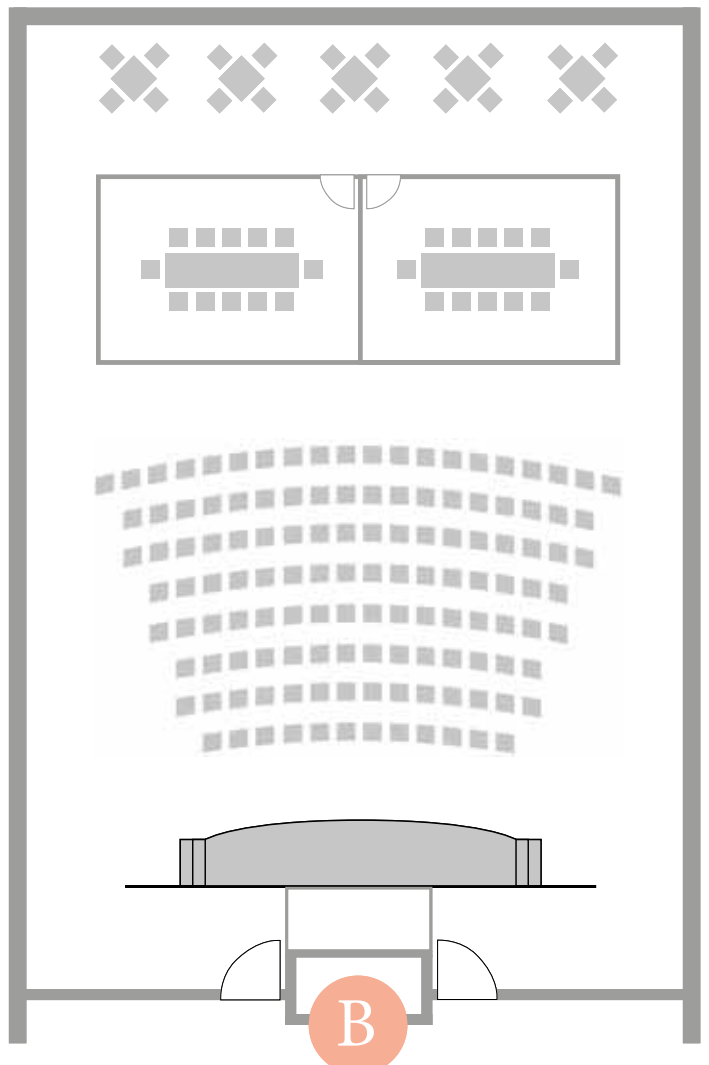
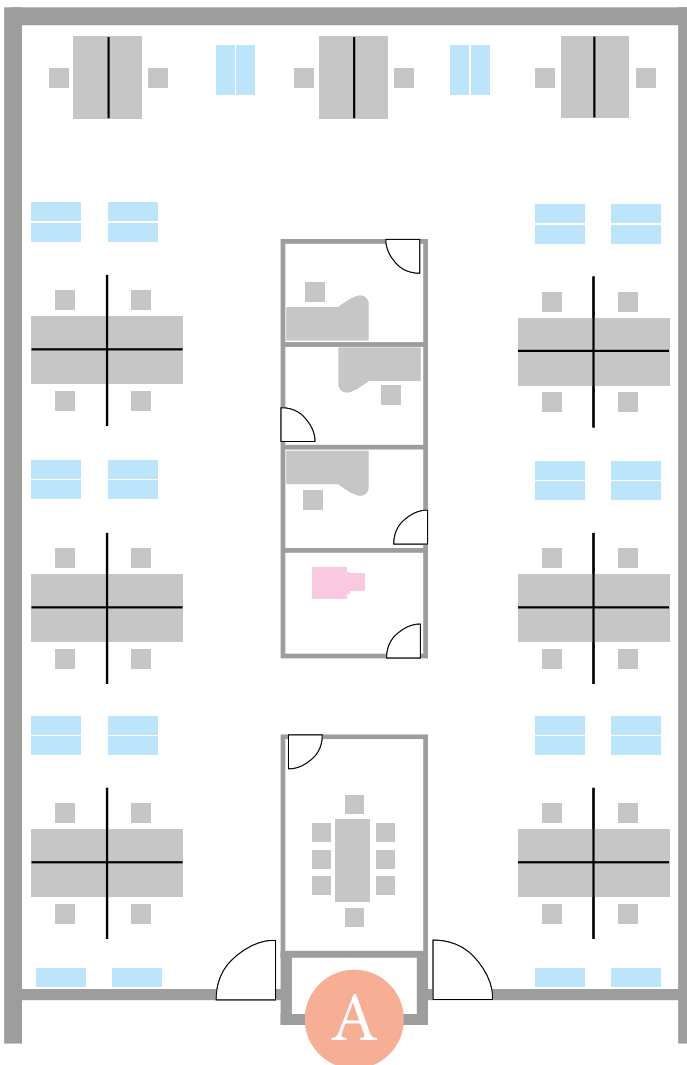

Examples of layout plans for same floor space.

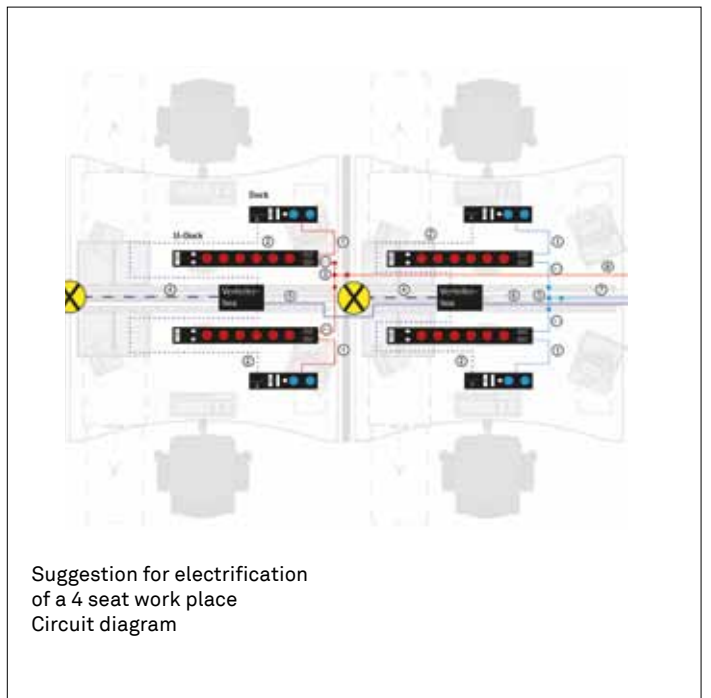
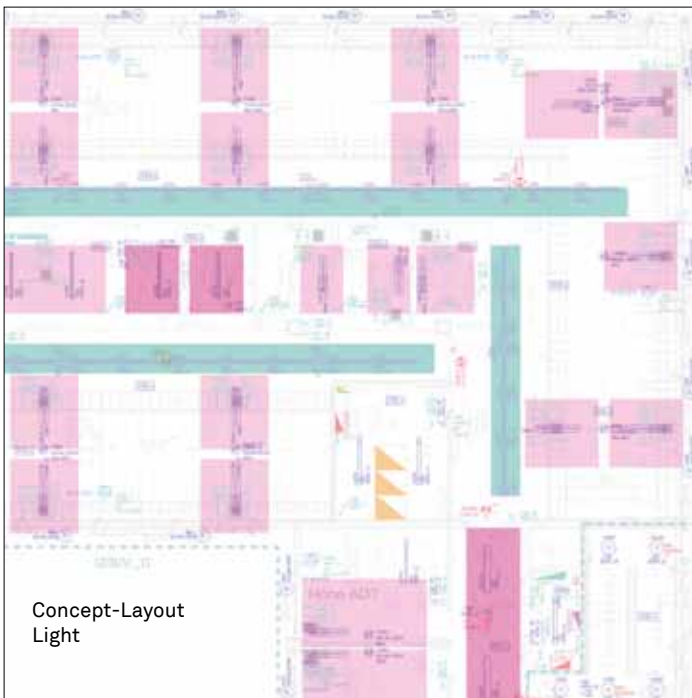
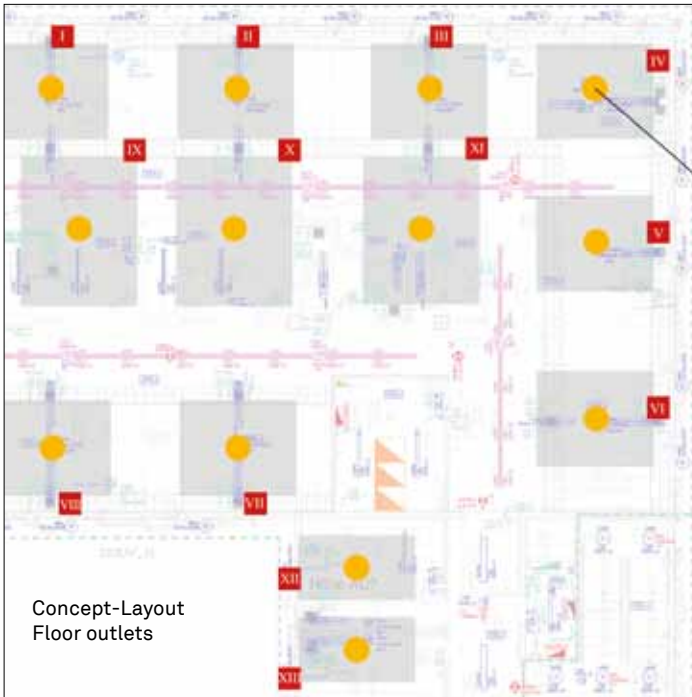
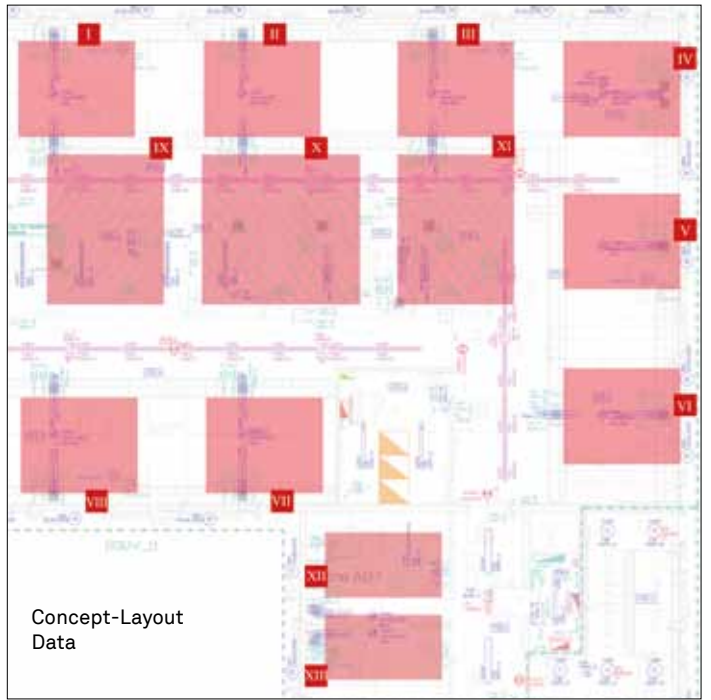
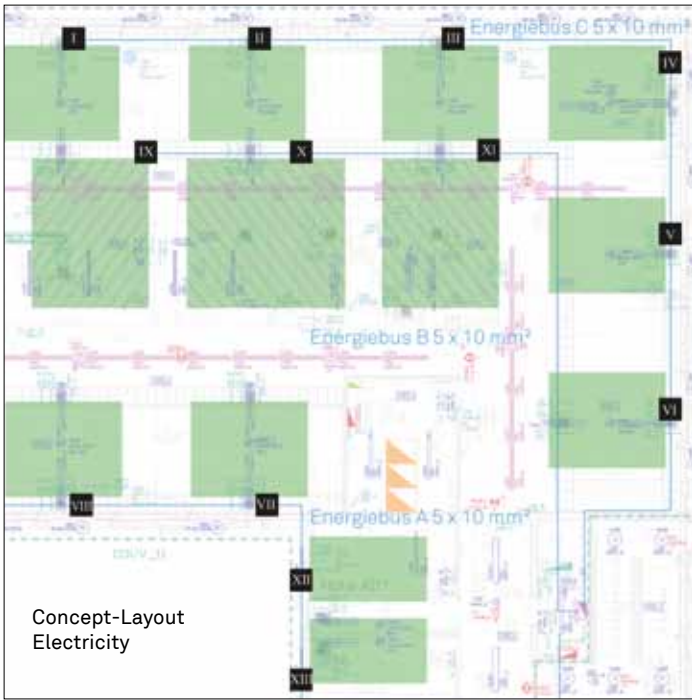

Planning with EVOLine®

We support and advise architects and electrical planners right from the start. We work with your layout plans to develop concepts for electricity, data, EVOLine floor outlets, building control, lighting down to individual work place configurations.

Contact us, we will show to you the large potential savings in new buildings and renovations. In a short time you will become a successful EVOLine expert.



Consolidation Point for electricity



Consolidation Point for data



Consolidation Point for wireless



EVOLine floor outlets



Kinetics Presence detector



EVOLine Kinetics Wall transmitter



Kinetics Wireless receiver



Kinetics gateway



EVOLine Dock on desk



EVOLine U-Dock below desk



EVoline® Living Office at Schulte

Purist design and intelligent technology in the Living Office at Schulte.

Schulte Elektrotechnik is one of the pioneers of innovative office infrastructure. For us that includes flexible and decentralized electrical distribution as well as user oriented high quality electrification of the work place.

Miles of installed cables do not fit this concept at all. You will neither find wall switches and wall sockets, nor ceiling lights – and the usual grid of sub-floor boxes is missing, too. Bundles of cables used in the traditional radial arrangement are replaced by cost-saving electrical ring lines.

In the Living Office area on the second floor of our new building extension you can witness the EVoline philosophy directly: In the central office area transparent floor panels provide a view of ring lines and Consolidation Points. You can find all EVoline products for varying electrical and data connections on the desks. We look forward to your visit!



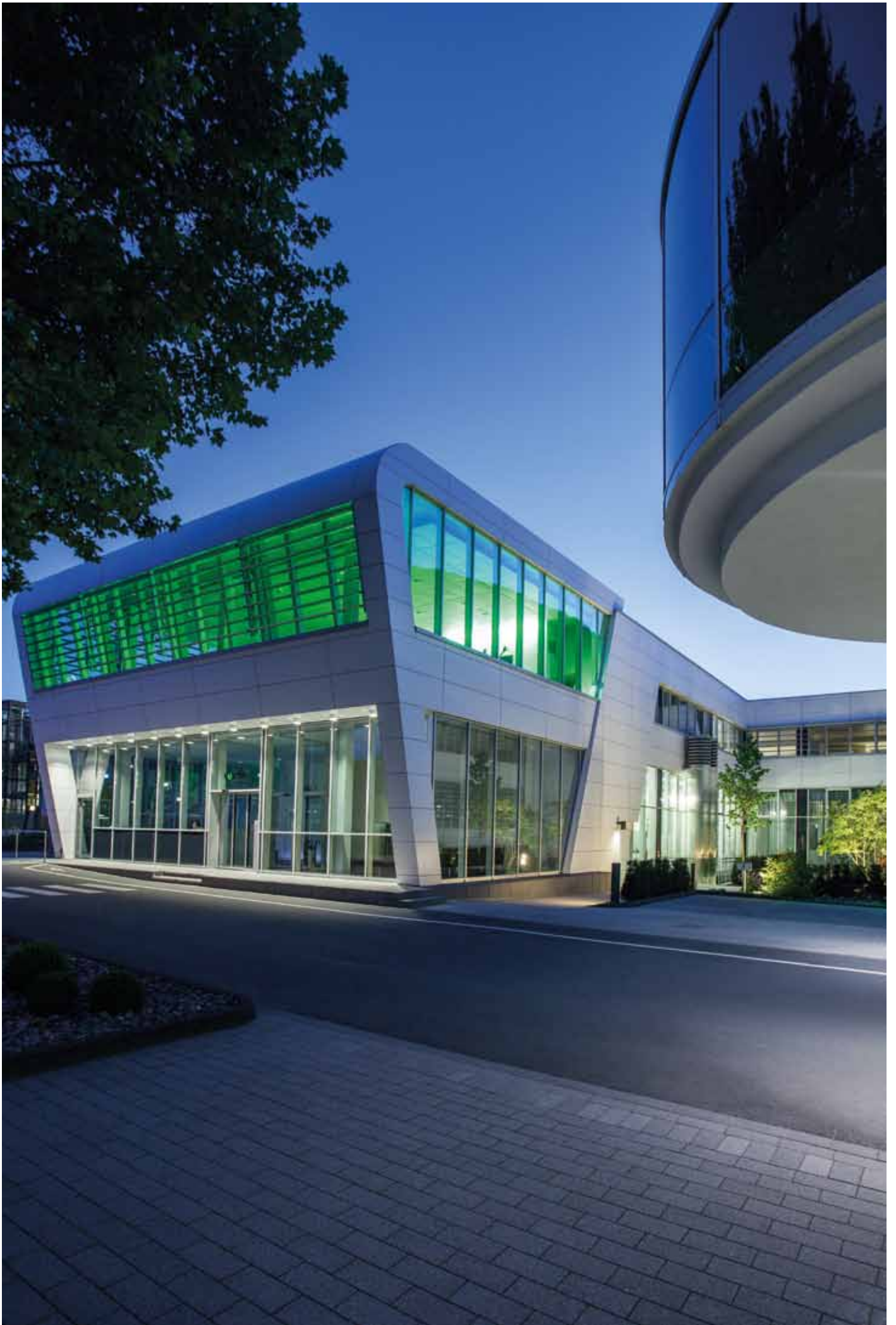

EV0line[®] at Vossloh

The traffic technology company Vossloh believes in EV0line. According to the principle of decentralized electrical distribution its new technical centre was equipped with consolidation points and separate electrical wiring for the sensitive IT and for general use.





EVoline[®] at Fraunhofer IA0

In the futuristic and award winning new building of Fraunhofer IA0, employees not only research the future of work, but actually live it. EVoline has co-developed the entire electrical infrastructure from decentralized Consolidation Points down to the individual equipment of work places, thereby supporting the innovative and flexible work culture of the institution.





EV0line[®] at Vodafone Campus

In December 2012, about 5000 Vodafone employees moved into the new company headquarters, the Vodafone Campus.

Here, the German headquarters of the telecommunications company houses highly different departments on almost 90000 square meters and presents itself in communicative transparency. Sustainability, energy efficiency and variability for future usage were essential design features. Therefore comfortable decentralized electrical distribution was installed: More than 800 Consolidation Points enable flexible use of the space. Comfortable supply of work places with electricity and data is ensured by 4500 EV0line Docks.



EV0line® Consolidation Point

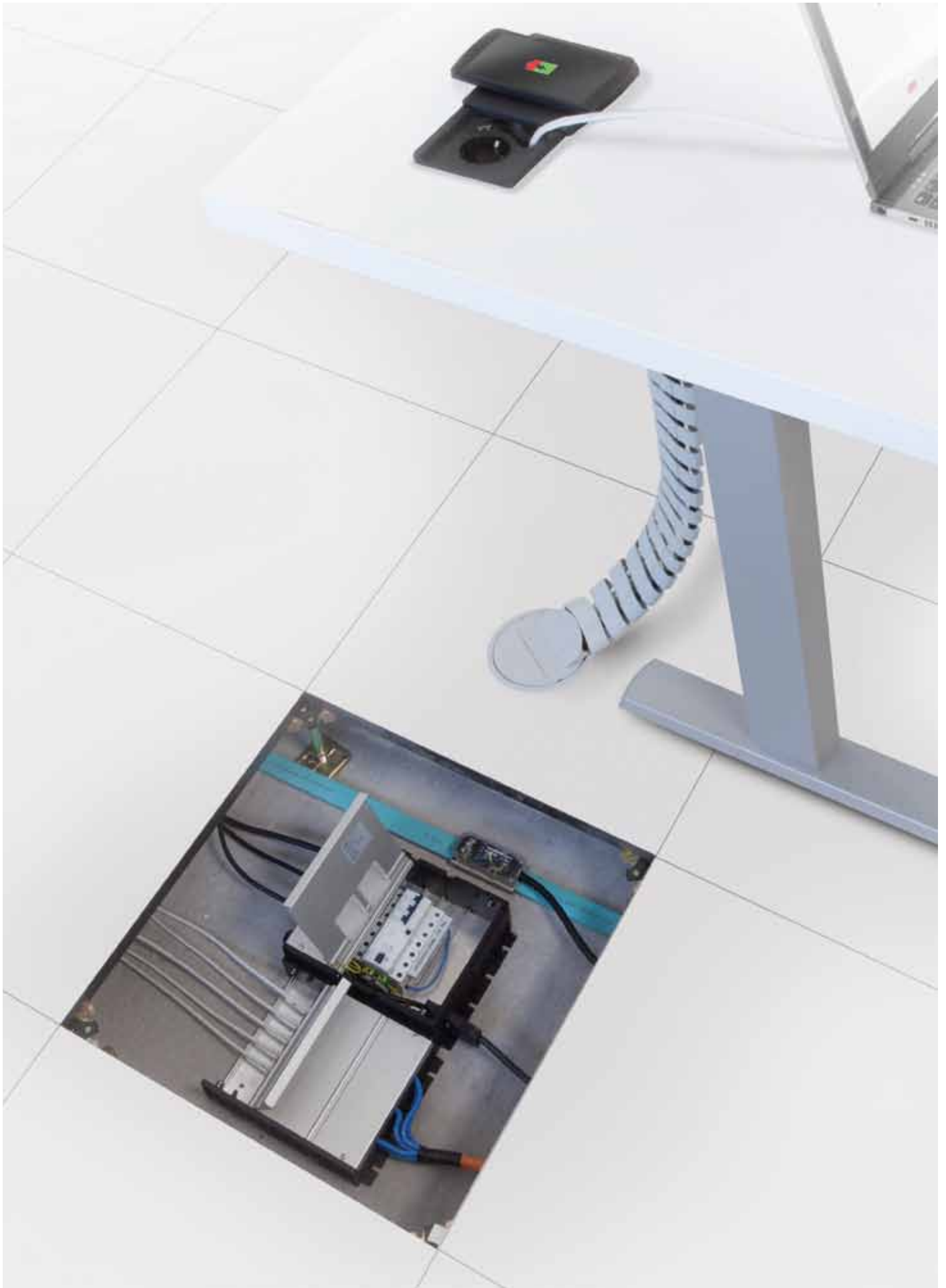

EVoline® Consolidation Point

Electrification of a building is only safe for the future, if it can react flexibly to changes in usage profiles.

The decentralized modular concepts of EVoline meet this challenge right from the start. EVoline Consolidation Points are the central hub. They are decentralized distribution stations on a ring line and enable local access to and protection of individual work groups. Cables are saved, and maximum operational reliability as well as flexibility for future changes in usage are ensured.

Our Consolidation Points feature the following characteristics:

- Modularity
- custom-made
- internal wiring with 2.5 mm² wires
- wires easy to reach for service
- simple installation
- ground connector at each conductive element
- positive connection of housings
- can be used for ring and bus lines
- screw lockable flaps
- connector labels
- for double and cavity floors
- adapts to flat or round cables



Consolidation Point Power



Consolidation Point combined

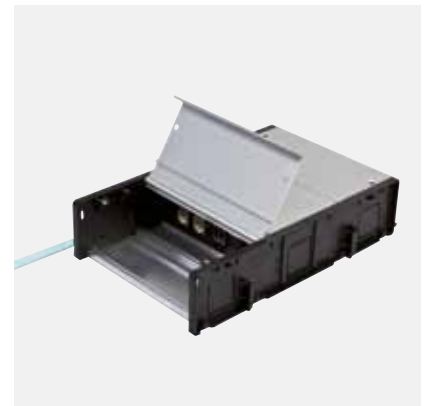

Consolidation Point combined

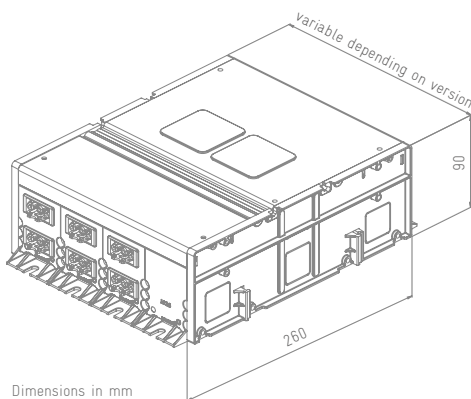

Dimensions in mm

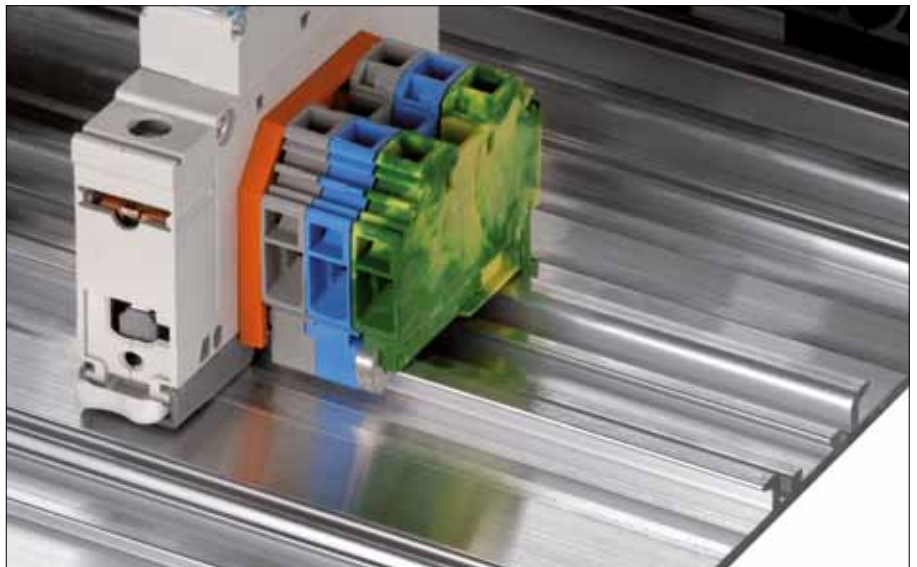

Description

Picture

Specification / Order number

EVOLine Power-CP 90

Aluminium housing with lateral plastic covers.
The outlet side has a brush strip and a screw lockable flap. The lengths of the elements adapt individually to the various versions. All metal parts are grounded and internal wiring is with 2.5 mm² wires as standard.
Each electrical phase connects to its own output socket.

Dimensions (W/H/L):
260 x 90 x 240 mm

Input side:
1 x input plug, 5-pole

Internal wiring:
1 x FI protection switch 4-pole, 40 A, 30 mA
3 x circuit breaker 16 A Type B

Exit side:
3 x output socket, 3-pole



WAGO WINSTA MIDI
1594 2000 0100

Wieland GST 18
1594 2000 0200

EVOLine Power-CP 90

Aluminium housing with lateral plastic covers.
The outlet side has a brush strip and a screw-lockable flap. The lengths of the elements adapt individually to the various versions. All metal parts are grounded and internal wiring is with 2.5 mm² wires as standard.
Electrical phase separation. 3 sockets per phase.

Dimensions (W/H/L):
260 x 90 x 300 mm

Input side:
3.0 m electrical supply cables 4 mm² and connector module for ring line 5 x 10 mm²

Internal wiring:
1 x FI protection switch 4-pole, 40 A, 30 mA
6x circuit breaker 16 A Type B

Exit side:
3 x output socket 3-pole, black/white for each phase



WAGO WINSTA MIDI 1594 2000 0300

Wieland GST 18:
1594 2000 0400

EVOLine Power-CP 90 Individual



Aluminium housing with lateral plastic covers.
The outlet side has a brush strip and a screw lockable flap.
The lengths of the elements adapt individually to the various versions. All metal parts are grounded and internal wiring is with 2.5 mm² wires as standard. Entry and exit sides equipped with WAGO, Wieland, or PG screw connectors following customer's requirements. Project specific devices are mounted in-line and wired accordingly.

Dimensions (W/H/L):
260 x 90 x (depending on customization) mm



EVOLine® Consolidation Point 60

Description	Picture	Specification / Order number
<p>EVOLine Data-CP 60 Aluminium housing with lateral plastic covers. Input side with openings for data cables up to 9 mm diameter, with snap-off covers. The outlet side has a brush strip and a screw-lockable flap. The lengths of elements adapt individually to the various versions. Equipment: 8 x ELBRO modular adaptor CAT6A</p> <p>Dimensions (W/H/L): 260 x 60 x 266 mm</p>		1594 1000 0100
<p>EVOLine Data-CP 60 Aluminium housing with lateral plastic covers. Input side with openings for data cables up to 9 mm diameter, with snap-off covers. Additional strain relief at the entry point for each individual data cable. The outlet side has a brush strip and a screw-lockable flap. The lengths of elements adapt individually to the various versions. Equipment: 6 x Nexans LANmark-6A</p> <p>Dimensions (W/H/L): 260 x 60 x 216 mm</p>		cable length 5 m 1594 1000 0200 cable length 10 m 1594 1000 0300
<p>EVOLine Power-CP 60 Aluminium housing with lateral plastic covers. Input side with cable glands. The outlet side has a brush strip and a screw-lockable flap. Equipment: 6 x 3-pole sockets</p> <p>Dimensions (W/H/L): 260 x 60 x 216 mm</p>		WAGO WINSTA MIDI 1594 0000 0100 Wieland GST 18 1594 0000 0200
<p>EVOLine Data-CP 60 Individual Aluminium housing with lateral plastic covers. The outlet side has a brush strip and a screw-lockable flap. The lengths of elements adapt individually to the various versions. Input side with openings for data cables up to 9 mm diameter, with snap-off covers.</p> <p>Dimensions (W/H/L): 260 x 60 x ? mm (depending on customisation)</p>		Individual version
<p>EVOLine Power-CP 60 Individual Aluminium housing with lateral plastic covers. The outlet side has a brush strip and a screw-lockable flap. The lengths of elements adapt individually to the various versions. All metal parts are grounded and internal wiring is with 2.5 mm² stranded wires as standard. Entry and exit sides equipped with WAGO, Wieland, or PG screw connectors following customer's requirements.</p> <p>Dimensions (W/H/L): 260 x 60 x ? mm (depending on customisation)</p>		Individual version

Description	Picture	Specification	Order number
<p>Floor outlet, empty Cable passage for installation in double and cavity floors. Removable cover opens on both sides. Made from halogen-free polyamide. Cover with bracket for EVOLine WireLane</p> <p>Mounting opening: Ø 125 mm</p>		<p>Cover black</p> <p>Cover grey</p>	<p>1594 9000 0000</p> <p>1594 9100 0000</p>
<p>Floor outlet complete with function insert, electrical socket insert VDE-compliant black, with contact protection, with 3 m cable and plug GST18. Bracket for EVOLine WireLane.</p> <p>Installation dimensions: Ø 125 mm</p> <p>Individual components available separately.</p> <p>Various country specific versions (different electrical socket inserts) available upon request.</p>		<p>Cover black</p> <p>Cover grey</p> <p>Function insert grey</p>	<p>1594 9000 0100</p> <p>1594 9100 0100</p>



Hightech Production

Greatest vertical integration ensures the quality of our products. Be it automatised large scale production of millions of patented special switches per year, or customized EV0line components in small numbers, at Schulte each and every piece is tested and documented individually.

Whether plastic parts or metal parts with silver contacts: All parts are produced in our own plant, tested throughout the production process. This pattern continues in our production lines. We produce zero-defect quality.

It goes without saying that we don't make use of temporary workers or piece work to manufacture our hightech products. Our employees work self-responsibly.





Made in Germany

Our mixed male-female team of excellent engineers and developers create our entire product range with special emphasis on maximum installation efficiency and detail. We build tools - in a modular way - mainly in our own toolmaking department.

Outsourcing remains a foreign word for us.

Therefore we updated to our company's logo:



invented and made by
Schulte Elektrotechnik,
Lüdenscheid, Germany





Innovations within the building

We do not just talk about environmental protection, energy independence and increasing energy costs – we are actively involved.

Already in 1976, in our first plant, we used the excess heat of plastic component production to heat the entire building of 5000 square meters – against the advice of experts: “Too risky to install plastic pipes in an industrial floor; the costs would buy many tons of heating oil, etc.” Our system functions perfectly to this day!

In our new building we take new risks and enter uncharted territory. A young scientist published a study about a water circulation system in connection with geothermal energy and concrete core activation in floor and ceiling. Rooms equipped with this system maintain a “comfort zone” throughout summer and winter. The excess heat produced in summer is stored in the soil at a depth of 100 meters; the back-flow is used for cooling.

Together with shades and blinds against direct impact of the sun an average temperature of 21 degrees is maintained throughout the year. In cold weather, the process is reversed.

In case of interruptions or lack of process heat from plastics production, a gas burner automatically engages to provide heat. The investments for this systems are quite high. We do not receive any subsidies for this new endeavour. However, we are sure that like in 1976, this time we will again be successful in our investment for us and the environment.



Markus Sommer, expert for near-surface geothermal energy. Doing a test drilling.



Concrete core activation in the ceiling before application of concrete.

Das Prinzip Konfigurierbarkeit The Principle of Configurability



Schulte Elektrotechnik GmbH & Co. KG

Headquarter and Showroom
Jüngerstr. 21
D-58515 Lüdenscheid
Germany

T +49 2351 / 94 81-0
F +49 2351 / 4 26 58

E-Mail info@schulte.com
www.evoline.com

Schulte Elektrotechnik reserves the right to change, at any time and without prior warning, the technical specifications of any product illustrated in this catalogue.

EVoline's International Offices and Distributors

Australia

Lincoln Group
National Administration Centre
76 Postle Street
Coopers Plains QLD 4108
Australia
Greg Dillon
National Product Management
Team Leader - Cabinet Hardware
T: +61 07 3722 8121
F: +61 07 3244 3279
[gdillon\(at\)lincolnsentry.com.au](mailto:gdillon(at)lincolnsentry.com.au)
www.lincolnsentry.com.au

Austria

Schulte Elektrotechnik GmbH
& Co. KG
Gebietsverkaufsleiter
Marcus Falk
Gießhüblerstraße 62 /
Top 4
A-2344 Maria Enzersdorf
Austria
M: +43 (0) 660 50 84 184
F: +43 (0) 22 36 38 99 96
[m.falk\(at\)schulte.com](mailto:m.falk(at)schulte.com)

Bahrain, Kuwait, Oman, Saudia Arabia, United Arab Emirates

Neumann Consulting
International
FZ L.L.C.
Office 314, Building 8
P.O. Box 502062
Dubai Media City
United Arab Emirates
Jürgen Neumann
T: +971 4 390 22 11
F: +971 4 390 8202
[ceo\(at\)dubainci.com](mailto:ceo(at)dubainci.com)

Belgium, Luxemburg, Netherlands

EVoline B.V.
Valkenlaar 51
4854GR Breda
The Netherlands
Frans Frishert
T: +31 - (0) 76 561 77 95
F: +31 - (0) 76 561 77 96
M: +31 - (0) 651 173 486
[f.frishert\(at\)evoline.nl](mailto:f.frishert(at)evoline.nl)
www.evoline.nl

Canada

Schulte Electro System
Corporation
41W020 Seavey Road
Sugar Grove, IL 60554-9573
USA
Julia Schulte
T: +1 (0) 630 409 9445
F: +1 (0) 630 406 0505
[info\(at\)evoline-usa.com](mailto:info(at)evoline-usa.com)
www.evoline-usa.com

Chile

EVoline Chile
Fernando de Arguello 8096
7650469 Vitacura
Santiago
Chile
Andrés Picker
T: +56 (0) 9 75 77 88 44
[a.picker\(at\)ali-cura.com](mailto:a.picker(at)ali-cura.com)

Czech Republic

EROCOMM spol. s.r.o.
Brandys nad Labem
CZ - 250 01 Drevce
Czech Republic
Michal Spevák
T: +420 326 910 950
F: +420 326 914 319
[m.spevak\(at\)erocomm.cz](mailto:m.spevak(at)erocomm.cz)

Denmark

Datasteel
Lillemølle 3
DK-6400 Sønderborg
Denmark
Dennis Hansen
T: +45 (0) 40242814
[dennis\(at\)datasteel.dk](mailto:dennis(at)datasteel.dk)

Denmark

OnlineCo ApS
Tietgensvej 16
DK-8600 Silkeborg
Denmark
Niels Aaboe
T: +45 (0) 21 62 54 68
[niels\(at\)onlineco.dk](mailto:niels(at)onlineco.dk)

Estonia

Agenda PRO Ltd.
Savimäe 8A,Vahi küla
60534, Tartumaa
Estonia
Kaimar Mölder
T: + 372 733 6336
F: + 372 504 9499
[agenda\(at\)agenda.ee](mailto:agenda(at)agenda.ee)
www.agenda.ee
skype: kaimaragendae

Finland

Savo Design & Technic Oy
Muuntotie 1
01510 Vantaa
Finland
Jani Felin
T: +358 20 7181 436
F: +358 20 7181 451
[jani.felin\(at\)savo.fi](mailto:jani.felin(at)savo.fi)
www.savo.fi

France

Schulte Elektrotechnik, Frankreich
9, Rue André Leroi Gourhan
78280 Guyancourt
France
Rachid Belhaimeur
T: +33 (0) 643 69 16 35
[r.belhaimeur\(at\)schulte.com](mailto:r.belhaimeur(at)schulte.com)
Erika Habig
T: +33 (0) 6 73 01 19 34
F: +33 (0) 1 84 18 00 78
[e.habig\(at\)schulte.com](mailto:e.habig(at)schulte.com)

Great Britain

Schulte + Loughborough
Electro Systems Ltd.
32 Prospect Place
Camden Road
Bath BA1 5JD
Great Britain
Jin Kaur
T: +44 (0) 1225 330242
F: +44 (0) 1225 448848
[info\(at\)sl-electro.co.uk](mailto:info(at)sl-electro.co.uk)
www.evoline.co.uk

Greece

Cosmol S.A.
228 Kifissias Ave.
152 31 Halandri, Athens
Greece
George P. Yannacacos
T: +30 210 6740 110
F: +30 210 6740 246
[g.yannacacos\(at\)cosmol.gr](mailto:g.yannacacos(at)cosmol.gr)
www.cosmol.gr

Hungary

Kiraly Trading K.F.T.
Rakospalota, Mogyorod utja 12-14
H-1151 Budapest
Hungary
Istvan Kiraly
T: +36 1 307 3800
F: +36 1 307 3802
[kiraly\(at\)kiralytrading.hu](mailto:kiraly(at)kiralytrading.hu)

Indonesia, Malaysia, Philippines, Singapore, Thailand

Schulte Elektrotechnik
Jüngerstraße 21
58515 Lüdenscheid
Germany
T: +49 (0) 23 51 / 94 81 0
F: +49 (0) 23 51 / 4 26 58
[info\(at\)schulte.com](mailto:info(at)schulte.com)

EVoline's International Offices and Distributors

Ireland

EVoline Ireland
1 Maple Grove
Carpenterstown Park
Castelknock
Dublin 15
Ireland
Paul Kelly
T: +35 3834 088579
F: +35 3531 8207953
paul.kelly(at)evolone.ie
www.evolone.ie

Italy

MORATTO MACCHINE ELETTRICI
CHE di Moratto & C. s.a.s.
Via A.Volta, 2
I - 31030 - Pero di Breda di Piave
- TV
P.IVA / Cod.Fisc. : 01593070269
Italy
Eligio Moratto
Michele Moratto
T: +39 0422 904032
F: +39 0422 90363
info(at)evolone.it
www.evolone.it

Latvia

Agenda PRO Ltd.
Savimäe 8A, Vahi küla
60534, Tartumaa
Estonia
Kaimar Mölder
T: +372 733 6336
F: +372 504 9499
agenda(at)agenda.ee
www.agenda.ee
skype: kaimaragendaee

Lithuania

Agenda PRO
Savimäe 8A, Vahi küla
60534, Tartumaa
Estonia
Kaimar Mölder
T: +372 733 6336
F: +372 504 9499
dainius(at)agenda.ee
www.agenda.ee
skype: kaimaragendaee

Malta

Future Habitats Ltd.
Upper Constitution Street
Mosta
Malta
Piera Fenech
T: +356 21 424251
F: +356 21 420596
piera.fenech(at)futurehabitats.com
www.futurehabitats.com

New Zealand

EVoline NZ Ltd
P O Box 69031
Glendene 0645
Auckland
New Zealand
Toni Farmilo
T: +64 800 386 546
F: +64 800 386 547
M: +64 21 878 578
evolinenz(at)xtra.co.nz
www.evolone.co.nz

Norway

EVoline Norge AS
Drammensveien 82 C
NO 0271 Oslo
Norway
Thorleiv Rotneim
T: +47 22446152
F: +47 22446153
M: +47 92831531
tr(at)evolone.no

Poland

P.P.H.U. „DE Korek“
ul. Piwna 15
98-220 Zdun'ska Wola
Poland
Zbigniew Kornacki
T: +48 0-43 824 65 54
F: +48 0-43 824 65 54
dekorek(at)dekorek.com.pl

Portugal

Sardinha & Leite, S.A.
Sede
Rua da Voltinha
Apartado 66
4416-901 Pedroso
Portugal
Paulo Magalhães
T: +351 227 860 100
F: +351 227 860 109
pmagalhaes(at)sardinha-leite.pt

Dinis Coelho Lda

SANJOTEC - Centro Empresarial e
Tecnológico de S. Joao da Madeira
Rua de Fundoes, No 151 Sala B 1.7
3700-121 S. Joao da Madeira
Portugal
Dinis Coelho
T: +351 256 001 923
F: +351 917 309 400
dcoelho(at)diniscoelho.pt

Romania

Cressent Import Export
str. Vasile Lucaciu nr. 163
430401 Baia Mare, MM
Romania
Wegroszta Zsolt
T: +40 262 214740
F: +40 262 217491
wegroszta(at)cressent.ro
www.cressent.ro

Russia

Nork Palm
Ryabinovaya, 61 A
121471 Moscow
Russia
Natalya Kuzmicheva
T: +7 (495) 921-39-99
F: +7 (495) 921-39-99
n.kuzmicheva(at)norkpalm.ru
www.norkpalm.ru
www.evolone-solution.ru
info@evolone-solution.ru

Slovakia

Erocomm SK s.r.o.
Koprivnicka 36
841 02 Bratislava
Slovakia
Jan Viskup
T: +421 905 940 055
F: +421 264 462 480
j.viskup(at)erocomm.sk

Spain

EVoline Espana
Calle escuela, 5 - bajo
E-12429 El Toro (Castellón)
Spain
Carlos Moroder
T: +34 964 123 142
F: +34 91 790 50 50
M: +34 629620631
c.moroder(at)schulte.com
www.evolone.es

Switzerland

A. Steffen AG
Elektrogroßhandel
Limmatstrasse 8
8957 Spreitenbach
Switzerland
Philippe Brantschen
T: +41 (0) 56 / 417 99 04
F: +41 (0) 56 / 417 99 10
philippe.brantschen(at)steffen.ch

Turkey

REHAU POLIMERI
KIMYA SAN. A.S.
Kore Sehitleri CAD. No. 42
34394 Zincirlikuyu
Istanbul
Turkey
Yavuz Yaman
T: +90 212 274 9655
F: +90 212 288 1031
Yavuz.yaman(at)rehau.com

Ukraine

Decorport Ltd
Artema str. 21
04053, Kiev
Ukraine
Natalia Cyganok
T: +38 044 223 66 93
F: +38 044 42 380 22
M: +38 050 25 947 25
info(at)decorport.com.ua
www.decorport.com.ua

USA

Schulte Electro System
Corporation
41W020 Seavey Road
Sugar Grove, IL 60554-9573
USA
Julia Schulte
T: +1 (0) 630 409 9445
F: +1 (0) 630 406 0505
info(at)evolone-usa.com
www.evolone-usa.com

EVOLine[®]

ePlace Design

Schulte Elektrotechnik GmbH & Co. KG

Jüngerstraße 21
D-58515 Lüdenscheid

phone +49 23 51 / 94 81-0
fax +49 23 51 / 4 26 58

E-Mail info@schulte.com
Internet www.evoline.com

